

SERVICE MANUAL

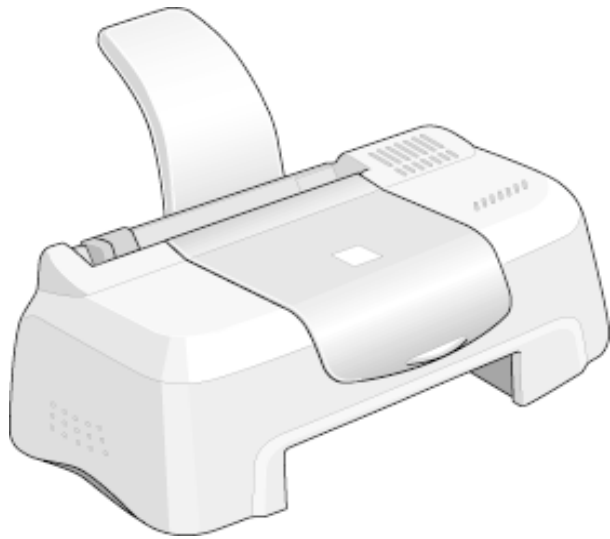

Color Inkjet Printer

EPSON STYLUS COLOR 580



EPSON®

Notice

- All rights reserved. No part of this manual may be reproduced, stored in a retrieval system, or transmitted in any form or by any means electronic, mechanical, photocopying, or otherwise, without the prior written permission of SEIKO EPSON CORPORATION.
- All effort have been made to ensure the accuracy of the contents of this manual. However, should any errors be detected, SEIKO EPSON would greatly appreciate being informed of them.
- The contents of this manual are subject to change without notice.
- All effort have been made to ensure the accuracy of the contents of this manual. However, should any errors be detected, SEIKO EPSON would greatly appreciate being informed of them.
- The above notwithstanding SEIKO EPSON CORPORATION can assume no responsibility for any errors in this manual or the consequences thereof.

EPSON is a registered trademark of SEIKO EPSON CORPORATION.

General Notice: Other product names used herein are for identification purpose only and may be trademarks or registered trademarks of their respective owners. EPSON disclaims any and all rights in those marks.

Copyright © 2000 SEIKO EPSON CORPORATION. Printed in Japan.

About This Manual

This manual describes basic functions, theory of electrical and mechanical operations, maintenance and repair procedures of EPSON Stylus Photo 720 / Stylus Photo EX3. The instructions and procedures included herein are intended for the experienced repair technicians, and attention should be given to the precautions on the preceding page.

PRECAUTIONS

Precautionary notations throughout the text are categorized relative to 1) Personal injury and 2) damage to equipment.

DANGER Signals a precaution which, if ignored, could result in serious or fatal personal injury. Great caution should be exercised in performing procedures preceded by DANGER Headings.

WARNING Signals a precaution which, if ignored, could result in damage to equipment.

The precautionary measures itemized below should always be observed when performing repair/maintenance procedures.

DANGER

1. ALWAYS DISCONNECT THE PRODUCT FROM THE POWER SOURCE AND PERIPHERAL DEVICES PERFORMING ANY MAINTENANCE OR REPAIR PROCEDURES.
2. NO WORK SHOULD BE PERFORMED ON THE UNIT BY PERSONS UNFAMILIAR WITH BASIC SAFETY MEASURES AS DICTATED FOR ALL ELECTRONICS TECHNICIANS IN THEIR LINE OF WORK.
3. WHEN PERFORMING TESTING AS DICTATED WITHIN THIS MANUAL, DO NOT CONNECT THE UNIT TO A POWER SOURCE UNTIL INSTRUCTED TO DO SO. WHEN THE POWER SUPPLY CABLE MUST BE CONNECTED, USE EXTREME CAUTION IN WORKING ON POWER SUPPLY AND OTHER ELECTRONIC COMPONENTS.

WARNING

1. REPAIRS ON EPSON PRODUCT SHOULD BE PERFORMED ONLY BY AN EPSON CERTIFIED REPAIR TECHNICIAN.
2. MAKE CERTAIN THAT THE SOURCE VOLTAGES IS THE SAME AS THE RATED VOLTAGE, LISTED ON THE SERIAL NUMBER/RATING PLATE. IF THE EPSON PRODUCT HAS A PRIMARY AC RATING DIFFERENT FROM AVAILABLE POWER SOURCE, DO NOT CONNECT IT TO THE POWER SOURCE.
3. ALWAYS VERIFY THAT THE EPSON PRODUCT HAS BEEN DISCONNECTED FROM THE POWER SOURCE BEFORE REMOVING OR REPLACING PRINTED CIRCUIT BOARDS AND/OR INDIVIDUAL CHIPS.
4. IN ORDER TO PROTECT SENSITIVE MICROPROCESSORS AND CIRCUITRY, USE STATIC DISCHARGE EQUIPMENT, SUCH AS ANTI-STATIC WRIST STRAPS, WHEN ACCESSING INTERNAL COMPONENTS.
5. REPLACE MALFUNCTIONING COMPONENTS ONLY WITH THOSE COMPONENTS BY THE MANUFACTURE; INTRODUCTION OF SECOND-SOURCE ICs OR OTHER NONAPPROVED COMPONENTS MAY DAMAGE THE PRODUCT AND VOID ANY APPLICABLE EPSON WARRANTY.

Contents

This manual consists of six chapters and Appendix.

CHAPTER 1. PRODUCT DESCRIPTIONS

Provides a general overview and specifications of the product.

CHAPTER 2. OPERATING PRINCIPLES

Describes the theory of electrical and mechanical operations of the product.

CHAPTER 3. TROUBLESHOOTING

Provides the step-by-step procedures for the troubleshooting.

CHAPTER 4. DISASSEMBLY AND ASSEMBLY

Describes the step-by-step procedures for disassembling and assembling the product.

CHAPTER 5. ADJUSTMENTS

Provides Epson-approved methods for adjustment.

CHAPTER 6. MAINTENANCE

Provides preventive maintenance procedures and the lists of Epson-approved lubricants and adhesives required for servicing the product.

APPENDIX Provides the following additional information for reference:

- Connector pin assignments
- Electric circuit boards components layout
- Exploded diagram
- Electrical circuit boards schematics

Symbols Used in This Manual

Various symbols are used throughout this manual either to provide additional information on a specific topic or to warn of possible danger present during a procedure or an action. Be aware of all symbols when they are used, and always read WARNING, CAUTION or NOTE messages.



Indicates an operating or maintenance procedure, practice or condition that, if not strictly observed, could result in injury or loss of life.



Indicates an operating or maintenance procedure, practice, or condition that, if not strictly observed, could result in damage to, or destruction of, equipment.



May indicate an operating or maintenance procedure, practice or condition that is necessary to accomplish a task efficiently. It may also provide additional information that is related to a specific subject, or comment on the results achieved through a previous action.

Revision Status

Revision	Issued Date	Description
Rev. A	August, 31 2000	First Release

Overview	10	Precautions.....	67
Features.....	10	Tools	68
Basic Specification	11	Work Completion Check	69
Printing Specification	11	Disassembly.....	70
Paper Specification	12	Housing removal.....	71
Printable Area	15	Printhead removal.....	72
PG Adjust Lever	16	CR motor removal	74
Ink Cartridge.....	17	Circuit board removal.....	76
Input Data Buffer.....	18	Waste drain ink pad unit removal.....	80
Electric Specification.....	18	PF motor removal	81
Reliability	18	LD Roller removal.....	82
Safety Approvals	18	HP/PE/IC Sensor removal	85
Acoustic Noise.....	18	Ink system unit removal (Cap & Pump unit).....	87
CE Marking (for 220V - 240V).....	19	Paper Eject Roller removal.....	89
Environmental Conditions	19	Paper feed roller removal	91
Interface Specification.....	21	CR unit removal.....	93
USB Interface	21	Disassembling ASF frame unit.....	96
IEEE1284.4 Protocol	22	Overview	100
Miscellanea	23	Required Adjustment.....	100
Panel-less control & Status Indication.....	23	Adjustment Program feature.....	101
Initialization.....	26	Adjustment Program Installation Procedure.....	102
Physical Specification	27	Adjustment Program Initial Setting menu	103
Consumables and Options	28	Sequential Repair Service Program feature.....	104
Overview	30	Feature	104
Printer Mechanism.....	30	Printhead removal.....	106
Printhead	31	Printhead replacement	109
Carriage Mechanism.....	33	Main board replacement	112
Paper Feeding Mechanism.....	34	CR unit replacement or removal.....	116
Paper Loading Mechanism (ASF Unit)	35	CR motor replacement or removal	116
Ink System Mechanism.....	39	Printer mechanism replacement.....	117
Ink Sequence.....	40	Waste ink pad replacement.....	117
Printing mode.....	42	Individual service adjustment program feature	118
Electrical Circuit Operating Principles.....	43	Get status function	118
C367 PSB/PSE board	43	Head cleaning function	118
C379MAIN-C Board	45	Initial ink charge function.....	118
Overview	51	Protection counter check/reset.....	118
Unit Level Troubleshooting	55	EEPROM check function	119
Overview	67	Refurbishment for DOA	120
		A4 Check pattern	121

Overview	123
Cleaning.....	123
Service Maintenance.....	124
Lubrication.....	125
Connector Summary	130
Major Component Unit.....	130
EEPROM Address Map.....	132
Component Layout	135
Exploded Diagram.....	137
Parts List.....	142
Electrical Circuits	145

CHAPTER

1

PRODUCT DESCRIPTION

1.1 Overview

Stylus Color 580 is developed newly for the low end product and realize a high quality graphic printing with the low price.

1.1.1 Features

Major features of this printer are as follows;

- High quality color printing
 - 1440dpi (H) x 720 dpi(V) dpi printing.
 - MACH technology (4 color printing. YMCK)
 - Micro wave, Super micro wave printing
 - Multi-Shot & Variable dot printing
- Control panel less
Host computer controls the printer.
- Built in I/F
 - USB
Windows and Macintosh exclusive printer.
- Small, space-saving
- Built-in auto sheet feeder
 - Holds 100 cut-sheets (65g/m²)
 - Holds 10 envelopes
 - Holds 10 transparency films
 - Holds 30 special paper



Figure 1-1. External View

1.2 Basic Specification

1.2.1 Printing Specification

PRINTING METHOD

- On demand ink jet

NOZZLE CONFIGURATION

- Black: 48 nozzles x 1 row
- Color: 45 nozzles x 1 row
15 nozzle is assigned for each 3 colors in the one row.
(Cyan, Magenta, Yellow)

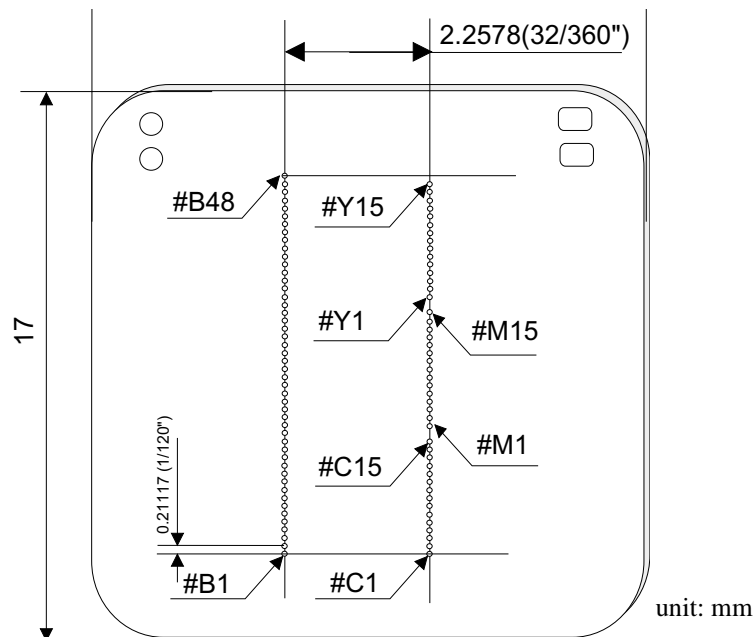

Figure 1-2. Nozzle Configuration (Seen from the Back of the Head)

PRINTING DIRECTION

- Bi-direction with logic seeking

PRINTING SPEED

- Character mode: Refer to the table below

Table 1-1. Character mode: black only

Character pitch	Character Quality	Printable Columns	CR Speed
10CPI	LQ	80column	20IPS

- Raster graphics mode: Refer to the table below.

Table 1-2. Printing Speed (Raster Graphics Mode)

Horizontal Resolution	Printable Area	Available Dot	CR Speed	Notes
480 dpi	8.26 inch	3968	14.1 IPS	Black mode
360 dpi	8.26 inch	2976	20 IPS	--
720 dpi	8.26 inch	5952	20 IPS	--
1440dpi	8.26 inch	11904	20 IPS	--

CHARACTER SPECIFICATION

- Character code: None. International character sets is not available. Only following characters are available.
 - ASCII 37 characters + Space code + One Symbol
 - Alphabet A-Z (Code 41H-5AH)
 - Number 0-9 (Code 30H-39H)
 - SPACE (Code 20H)
 - Symbol # (Code 23H)
 - Typeface
 - Bit map LQ font: EPSON Courier 10CPI

CONTROL CODE

- ESC/P for Stylus Color 580
- EPSON Remote command

PAPER FEED SPECIFICATION

- Feeding Method: Friction feed with ASF
- Paper Path: Cut sheet ASF (Top entry - Front out)
- Line Interval: Programmable by 1/6 inch or 1/360 inch
- Paper Feed Speed:
271.9ms 10 ms (10.16 mm (2/5 inch) at paper feed)
1.67inch/sec (at continuous paper feed)

1.2.2 Paper Specification

CUT SHEET

- Size:
 - A4 (210 x 297 mm)
 - Letter (216 x 279 mm)
 - B5 (182 x 257 mm)
 - Legal (216 x 356 mm)
 - Statement (139.7mm x 215.9mm)
 - Executive (190.5 x 254 mm)
- Thickness (plain paper):
0.08mm to 0.11mm(0.003 to 0.004")
- Weight:
64g/m² to 90g/m² (17lb to 24lb / 55 to 78 kg)
- Paper quality:
Exclusive paper, Bond paper, Plain paper, recycled paper
- ASF hopper available capacity
100 sheets
- No wrinkled, scuffing, torn or folded paper be used.
- No curled paper more than 5mm be used.



TRANSPARENCY, GLOSSY PAPER

- Size
A4 (210mm x 297mm)
Letter (216mm x 279mm)
- Thickness
0.075mm to 0.085mm
- Quality
Exclusive paper
- ASF hopper available capacity
1sheet

NOTE: *Transparency printing is available only in the normal temperature*

ENVELOPE

- Size:
No.10 (241.3 mm x 104.8 mm)
DL (220 mm x 110 mm)
C6 (162 mm x 114 mm)
4"x 6"(220mm x 132mm)
- Thickness
0.16mm to 0.52mm
- Weight
45g/m² to 75g/m²
- Quality
Bond paper, Plain paper, Air mail
- ASF hopper available capacity
10sheets

NOTE: * *Envelope printing is available only in the normal temperature.*
* *Keep the longer side of the envelope horizontally at setting.*



- Use above mentioned paper at normal temperature.
(temperature = 15 to 25%, humidity = 40 to 60% RH)
- No wrinkled, scuffing, torn or folded paper be used.
- No curled paper more than 5mm be used.
- No paper with glue on flap be used.
- No double envelops nor with window envelops be used.
- Do not print on the back.

INDEX CARD

- Size
A6 Index card (105mm x 148mm)
A5 Index card (148mm x 219mm)
5 x 8" Index Card (127mm x 203mm)
10 x 8" Index card (127mm x 203mm)
- Thickness
Less than 0.23mm
- ASF hopper available capacity
30sheets

SPECIAL PAPER

Paper type: EPSON exclusive paper

- Photo Quality Ink Jet Paper
 - A4 (210 x 297 mm)
 - A6 (105 x 148 mm)*
 - B5 (182 x 257mm)
 - Letter (216 x 279 mm)
 - Legal (216 x 356 mm)
 - 5 x 8" (127 x 203 mm)*1
 - 8 x10" (100 x 148 mm)*1
- 360 dpi Ink Jet Paper
 - A4 (210 x 297 mm)
 - Letter (216 x 279 mm)
- Transparencies *2)
 - A4 (210 x 297 mm)
 - Letter (216 x 279 mm)
- Photo Quality Glossy Film*2)
 - A4 (210 x 297 mm)
 - A6 (105 x 148 mm)*1
 - Letter (216 x 279 mm)
- Photo Paper (PP2)
 - A4 (210 x 297 mm)
 - Letter (216 x 279 mm)
 - Photo quality card 2 (100 x 148 mm)*1
 - Panorama (210 x 594 mm)
 - 4" x 6"(113.6 x 175.4)
 - 100mm x 150mm
 - 200mm x 300mm
- Photo Sticker
 - A4 (210 x 297 mm)
 - A6 (105 x 148 mm)
 - 8 "x 10" (100 x 148 mm)*1

- Iron-ON Transfer Paper
 - A4 (210 x 297 mm)
 - Letter (216 x 279 mm)
- Matte Paper
 - A4 (210 x 297 mm)
 - Letter (216 x 279 mm)
- High Quality Normal Paper
 - A4 (210 x 297 mm)

NOTE: *1): Set the enclosed loading support sheet as the last sheet in the ASF.
 *2): Set the plain paper as the last sheet in the ASF.



**Use above mentioned paper at normal temperature.
 (temperature = 15 to 25%, humidity = 40 to 60% RH)**

1.2.3 Printable Area

CUT SHEET

Refer to the following table. As for the each margin area, refer to the Figure 1-3

Table 1-3. Printable Area for Cut Sheet

Paper Size	Paper Width	Paper Length	LM/RM/ TM	BK Bottom Margin(*1)	Color Bottom Margin (*1,*2)
A4	210mm	297mm	3mm	14 mm or more than 3 mm	21mm or more than 3mm
Letter	216mm	279mm	3mm	14 mm or more than 3 mm	21mm or more than 3mm
B5	182mm	257mm	3mm	14 mm or more than 3 mm	21mm or more than 3mm
Legal	216mm	356mm	3mm	14 mm or more than 3 mm	21mm or more than 3mm
Statement	139.7mm	215.9mm	3mm	14 mm or more than 3 mm	21mm or more than 3mm
Executive	190.5mm	254mm	3mm	14 mm or more than 3 mm	21mm or more than 3mm

NOTE: *1): Bottom margin can be set up to 3mm at minimum when the paper length is designated with “ESC(S” command.) However, the printing quality is not guaranteed in the area ranging from 3mm to 14mm, from the form lower end. When the paper length is not designated, the bottom margin must be wider than 14 mm.

*2): Bottom margin for color printing can be set up 3mm at minimum when the paper length is designated with “ESC(S” command.). However, guaranteed print area of color printing is narrow than BK (monochrome)printing. This is due to the each color nozzles is assigned in the one row nozzles.

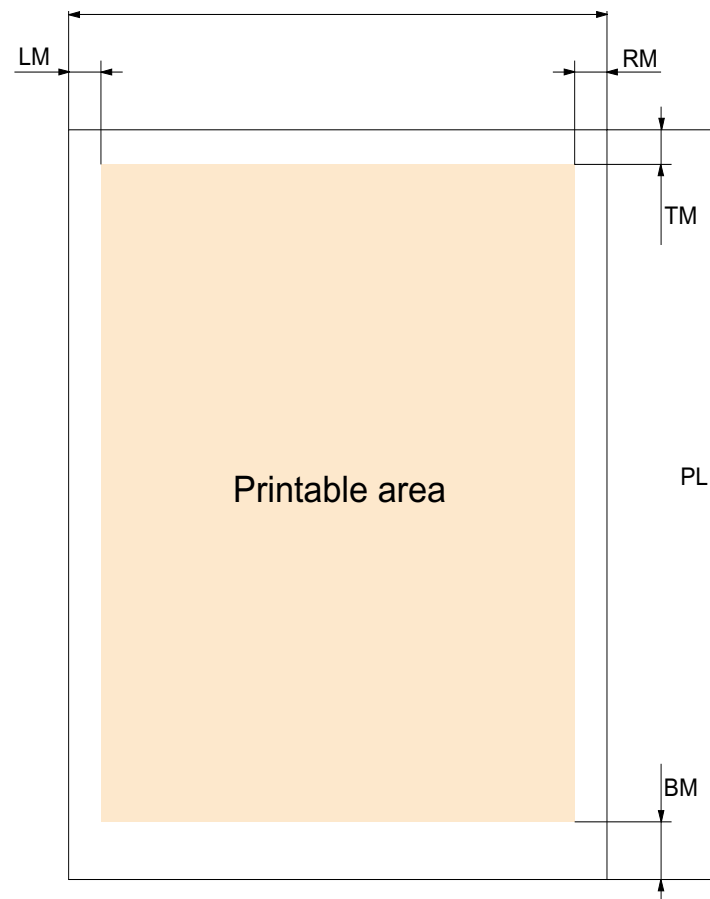

Figure 1-3. Printable Area

ENVELOP (PRINTABLE AREA)

Refer to the following table.

Table 1-4. Printable area for Envelop

Paper Size	Paper Width	Paper Length	LM	RM/TM	BK Bottom Margin(*1)	Color Bottom Margin (*1,*2)
#10	241mm	104.8 mm	28mm	3mm	14 mm or more than 3 mm	21mm or more than 3mm
DL	216mm	279mm	7mm	3mm	14 mm or more than 3 mm	21mm or more than 3mm
C6	182mm	257mm	3mm	3mm	14 mm or more than 3 mm	21mm or more than 3mm

NOTE: *1): Bottom margin can be set up to 3mm at minimum when the paper length is designated with “ESC(S” command.) However, the printing quality is not guaranteed in the area ranging from 3mm to 14mm, from the form lower end. When the paper length is not designated, the bottom margin must be wider than 14 mm.

*2): Bottom margin for color printing can be set up 3mm at minimum when the paper length is designated with “ESC(S” command.). However, guaranteed print area of color printing is narrow than BK (monochrome)printing. This is due to the each color nozzles is assigned in the one row nozzles.

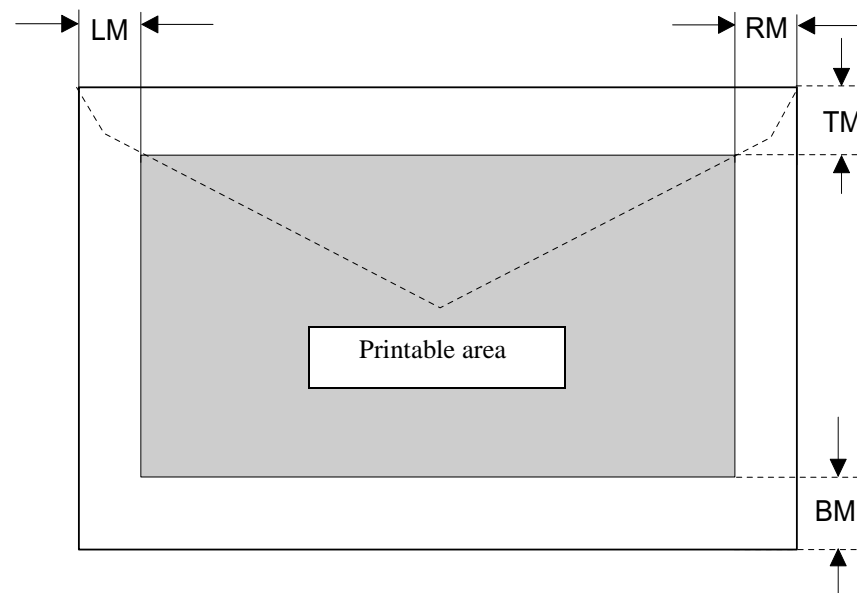

Figure 1-4. Printable area for Envelop

1.2.4 PG Adjust Lever

Unlike other products, this printer dose not have the PG (Platen Gap) adjust lever in the printer mechanism. So, the Platen Gap value can not be changed according to the paper thickness.

1.2.5 Ink Cartridge

INK CARTRIDGE (BLACK)

- Type: Exclusive cartridge
- Color: Black
- Print capacity: 270 pages/A4 (ISO/IEC 10561 Letter Pattern at 360dpi)
- Ink life: 2 years from production date
- Storage temperature:
 - -30°C to 60°C
Being transported, within 120 hours at 60°C, within a month at 40°C
 - -30°C to 40°C
Packing storage, within a month at 40°C
 - -20°C to 40°C
Mounted on the printer, within a month at 40°C
- Dimension: 19.8mm (W) x 52.7 mm (D) x 38.5mm (H)

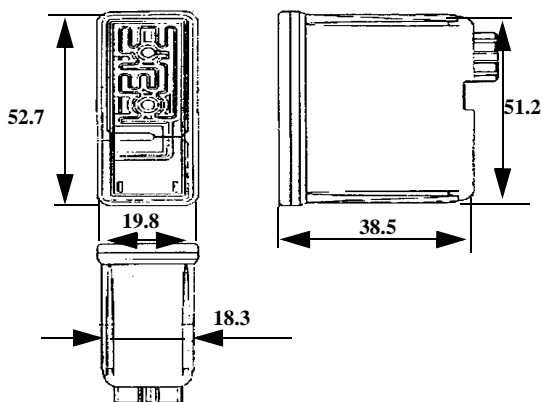

Figure 1-5. Black Ink Cartridge

COLOR INK CARTRIDGE

- Type: Exclusive cartridge
- Color: Magenta, Cyan, Yellow
- Print capacity: 150 pages/A4 (360dpi, 5% duty each color)
- Ink life: 2 years from production date
- Storage temperature:
 - -30°C to 60°C
Being transported, within 120 hours at 60°C, within a month at 40°C
 - -30°C to 40°C
Packing storage, within a month at 40°C
 - -20°C to 40°C
Mounted on the printer, within a month at 40°C
- Dimension: 42.9mm (W) x 52.7 mm (D) x 38.5mm (H)

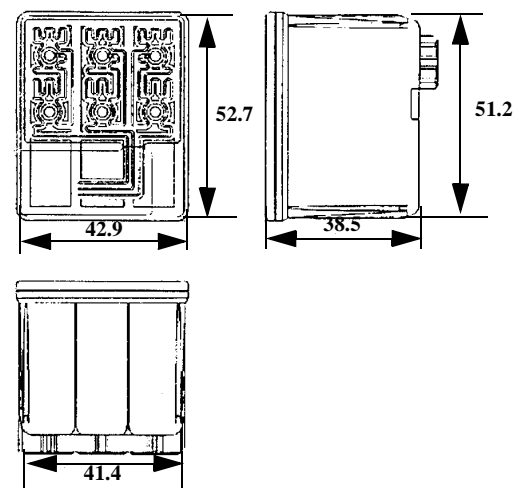

Figure 1-6. Color Ink Cartridge

1.2.6 Input Data Buffer

- Buffer: 16Kbytes

1.2.7 Electric Specification

120V VERSION

- Rated voltage: AC 120V
- Input voltage range: AC 99 -132V
- Rated frequency range: 50 - 60Hz
- Input frequency range: 49.5-60.5 Hz
- Rated current: 0.4A(Max 0.5A)
- Power consumption: Approx. 21W (ISO/IEI 10561 Letter pattern)
Approx. 5W in Standby mode
Energy star compliant
- Insulation Resistance: 10 M ohms min.
(between AC line and chassis, DC 500V)
- Dielectric Strength: AC 1000 V rms. 1 minute or
AC 1200 V rms 1 second
(between AC line and chassis)
- Leak Current: less than 0.25mA(input:100V/50Hz)
less than 0.75mA(input: 138V/60Hz)

220 - 240V VERSION

- Rated voltage: AC 220 - 240V
- Input voltage range: AC 198 -264V
- Rated frequency range: 50 - 60Hz
- Input frequency range: 49.5-60.5 Hz
- Rated current: 0.2A (Max. 0.3A)

- Power consumption: Approx. 21W (ISO/IEI 10561 Letter pattern)
Approx. 5.5W in standby mode
Energy star compliant
- Insulation Resistance: 10 M ohms min.
(between AC line and chassis, DC 500V)
- Dielectric Strength: AC 1500 V rms. 1 minute
- Leak Current: less than 0.75mA (input: 276V/60Hz)

1.2.8 Reliability

- Total print volume: : 10000 pages (A4.Letter) (except ESP,EIO,EPC)
: 20000 pages (A4, Letter) (ESP, EIO,EPC)
- Printhead Life: 4000 million dots/nozzle

1.2.9 Safety Approvals

120V VERSION

- Safeties standards: UL1950 with D3
CSA C22.2 No.950 with D3
- EMI: FCC part15 subpart B class B
CSA C108.8 class B

220V -240V VERSION

- Safety standards: EN60950(VDE)
EN55022 (CISPR Pub.22) Class B
- EMI: EN55022 (CISPR Pub.22) Class B

1.2.10 Acoustic Noise

- Level: Approx. 45dB(A) (According to ISO 7779)

1.2.11 CE Marking (for 220V - 240V)

- Low Voltage Directive 73/23/eec : ENN60950
- EMC Directive 89/336/EEC : EN55022 Class B
 - : EN61000-3-2
 - : EN610000-3-3
 - : EN50082-1
 - IEC801-2
 - IEC801-3
 - IEC801 -4

1.2.12 Environmental Conditions

TEMPERATURE

- Operating: 10 to 35°C (Refer to Figure 1-7)
- Non-operating: -20 to 60°C (with shipment container)
 - 1 month at 40°C
 - 120hours at 60°C

HUMIDITY

- Operating: 20 to 80% RH
 - without condensation, Refer to Figure 1-7
- Non-operating: 5 to 85% RH
 - without condensation, with shipment container

The environmental condition should be within the range shown in the figure below.

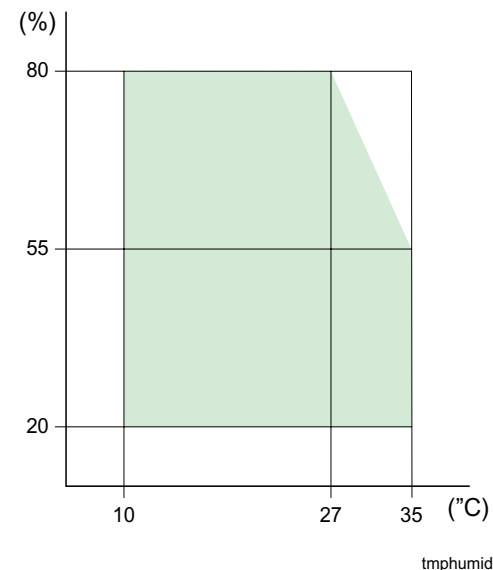

Figure 1-7. Environmental Condition

RESISTANCE TO SHOCK

- Operating: 1 G, within 1ms (operating)
- Non-operating: 2G, within 2ms (with shipment container)

RESISTANCE TO VIBRATION

- Operating: 0.15G
- Non-operating: 0.50G (with shipment container)

CAUTION

- When non-operating, make sure the printhead is capped.
- When transporting, make sure the printhead is capped and keep the ink cartridge mounted on the printer.
- Under the power OFF condition, if the printhead is not capped, turn ON the printer after installing the ink cartridge, and turn off the printer after the capping has completed.
- If the printer kept under -40°C , the ink inside the printhead and inside the ink cartridge will be frozen.
It takes 3 hours at 25°C to recover once frozen ink to be ready for use.

1.3 Interface Specification

This printer has USB interface as standard.

1.3.1 USB Interface

Standard: Based on:
 “Universal Serial Bus Specifications Rev. 1.0”
 “Universal Serial Bus Device Class Definition for Printing Device Version 1.0”
 Bit Rate: 12Mbps (Full Speed Device)
 Date Encoding:NRZI
 Adaptable Connector:USB Series B
 Recommended Cable Length:2 meters

Table 1-5. Connector pin Assignment and Signals

Pin No.	Signal Name	I/O	Function Description
1	VCC	-	Cable power. Max. power consumption is 2mA.
2	-Data	Bi-D	Data
3	+Data	Bi-D	Data, pull up to +3.3 V via 15K ohm resistor.
4	Ground	-	Cable ground

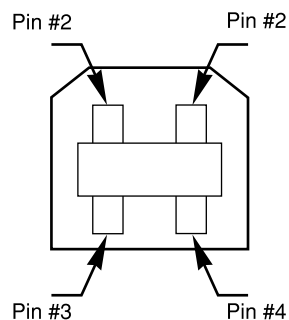

Figure 1-8. USB Pin Assignment

- Device ID
 The printer sends following device ID string when it is requested.
 [00H] [5AH]
 MFG: EPSON;
 CMD: ESCPL2, BDC, D4;
 MDL: Stylus[SP]COLOR[SP]580;
 CLS: PRINTER;
 DES: EPSON[SP]Stylus[SP]COLOR[SP]580;

NOTE: [00H] denotes a hexadecimal value of zero.
 MDL value depends on the EEPROM setting. Refer to Appendix.

1.3.2 IEEE1284.4 Protocol

The packet protocol described by IEEE1284.4 standard allows a device to carry on multiple exchanges or conversations which contain data and /or control command with another device at the same time across a single point-to-point link. The protocol is not, however, a device control language. It does provide basic transport-level flow control and multiplexing services. The multiplexed logical channels are independent of each other and blocking of one has no effect on the others. The protocol operates over IEEE1284.4.

Three function modes of IEEE1284.4 protocol, “On”, “Off” and “Auto” are available, and the setting is defined based on the data stored in the value in EEPROM address 25<H>.

- On
Communication in IEEE1284.4 packet mode is started by receiving a magic string (1284.4 synchronous commands). Until a magic string is received, other commands are discarded.
- Off
Communication is carried out in the conventional mode. A magic string (1284.4 synchronous commands) is discarded.
- Auto
Communication is carried out in the conventional mode until a magic string (1284.4 synchronous commands) is received. By receiving a magic string, communication in IEEE1284.4 packet mode is started.

The factory setting for IEEE1284.4 mode is “ON”. But, after complete the initial ink charge operation, the setting of the EEPROM is set to “AUTO”. The change in this setting will be effective when the power is back on after the initial ink charge operation.

1.3.3 Miscellanea

1.3.3.1 Receive Data Buffer Full Operation

Generally, hosts abandon data transfer to peripherals when a peripheral is in busy state for dozens of seconds continuously. In order to prevent the long busy status, printer start receive the data every 1 second when the reset of the input buffer become less than several hundreds of bytes. The printer will be in busy state continuously when the input buffer finally gets full. This operation is not IEEE 1284.4 protocol

1.3.4 Panel-less control & Status Indication

On this product, the control panel is not assembled in. So, Printer driver utility (STM39) allows to control the printer operation instead of the Control panel and indicates the printer status include the several errors.

1.3.4.1 Error Indication on Status Monitor 3

Following printer status is displayed in the STM3 (Status monitor 3).

❑ Ink End/Low Error

When the printer is in the ink end or low condition, the STM3 displays the status. If the “How to” button is clicked, the Ink Cartridge Replacement Utility runs and it reads the ink cartridge replacement procedure step by step.

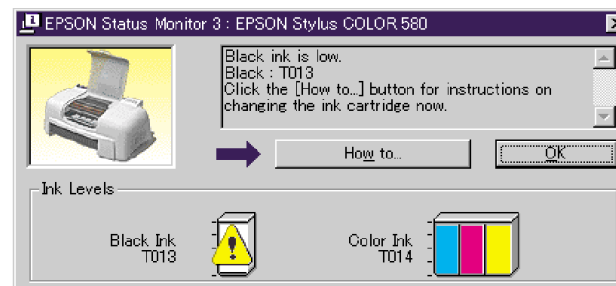

Figure 1-9. Ink low error indication

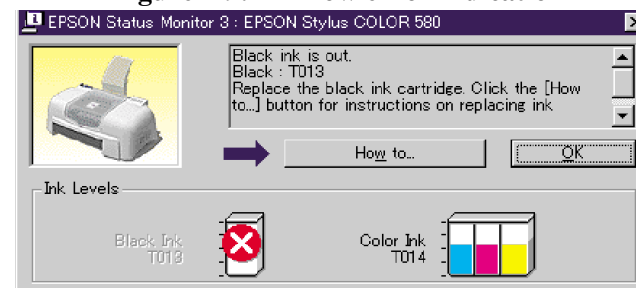

Figure 1-10. Ink out error indication

❑ **Paper out Error**

When the paper is not loaded correctly from the ASF to the PF roller, this error is displayed on the STM3.

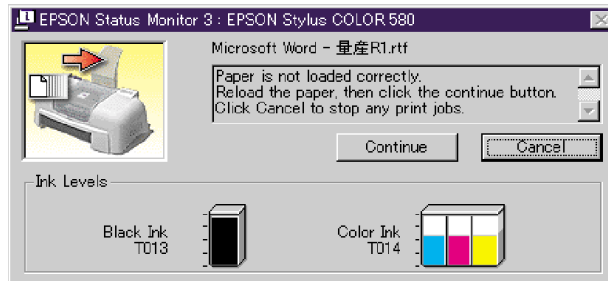

Figure 1-11. Paper out error indication

❑ **Paper jam error**

When the paper is jammed between the PE sensor and the Paper eject roller, this error indication is displayed on the STM3.

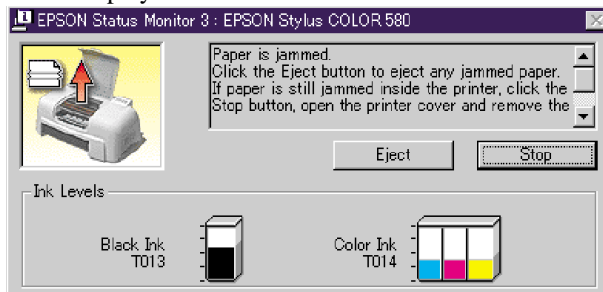

Figure 1-12. Paper jam error indication

❑ **Fatal Error**

When the general error has occurred, this error is displayed on the STM3. For example, circuit damage, motor damage...etc.

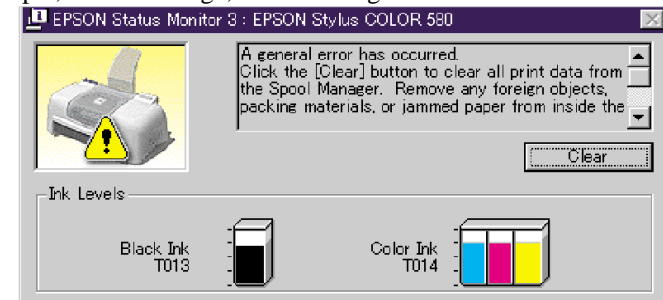

Figure 1-13. Fatal Error indication

❑ **Maintenance Error**

When the waste ink counter reaches to the specific counter value, this error is displayed on the STM3.

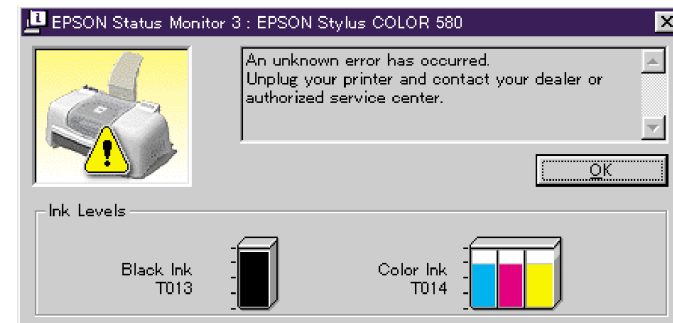

Figure 1-14. Maintenance Error indication

Communication Error

When the printer can not communicate with PC, this message is displayed on the STM3.



Figure 1-15. Communication error indication

1.3.4.2 Status Monitor 3 function

STM3 in the Printer driver utility allows to perform the following functions.

- Nozzle Check Pattern printing**
The printer prints the nozzle check pattern and the 6 digits code of the firmware version & 6 digits code of the CPU Mask version.
- Head cleaning**
- Bi-d adjustment pattern printing**
- Print head alignment adjustment**
- Cancel the Paper out error**
When the paper is not loaded correctly, STM3 (status monitor 3) display the following message and the Paper Error can be canceled by clicking the “Continue” button in the STM3.
“Paper is not loaded correctly. Reload the paper, then click the “Continue” button. Click “Cancel” to stop any print jobs.”
- Cancel the Paper jam error**
When the paper is jammed, STM3 display the following message and printer attempt to eject the Jammed paper by clicking the “EJECT” button.
“Paper is jammed”. Click the “Eject” button to eject any jammed paper.
If paper is still jammed inside the printer, click the “Stop” button, open the printer cover and remove the paper. Then close the printer cover and click the “Reset” button.
Moreover, if the “Stop” button is clicked, the printing is stopped and the “Reset” button is displayed. If once the “Reset” button is clicked, the printer setting is reset.
- Ink Cartridge Exchange utility**
According to the procedure displayed, I/C can be replaced. In this function, CR moves to the I/C replacement position automatically and turn back to the home position after setting the I/C in the CR unit. This function is always available, not only Ink end or low condition.
- Printer Setup utility**
This utility instructs the printer set up procedure (I/C setting procedure) and print the nozzle check patten and head cleaning. Additionally, printhead alignment pattern is printed and allow the user to adjust the bi-d printing alignment.

1.3.5 Initialization

The printer have 3 types of initialization. The initialization operations executed by each initialization method are described below.

HARDWARE INITIALIZATION

This printer initializes itself when it is turned power on or printer recognized the Reset command (D4 command). On this initialization, following actions are performed.

- Initialize printer mechanism
- Clear the input data buffer
- Clear the print buffer
- Set default values

Software initialization

Initialization command, “ESC@” also initializes the printer.

On this initialization, following actions are performed.

- Clear the print buffer
- Set default values

Power On initialization except I/F

This printer initializes itself when the printer receive the IEEE1284.4 reset command or the USB cable is pull off.

On this initialization, following actions are performed.

- Initialize printer mechanism
- Clears the input data buffer
- Clears the print buffer
- Sets default values except I/F setting.

1.4 Physical Specification

DIMENSIONS

- Stylus Color 580: 431 mm (W) x 311mm (D) x 271mm (H)
(Printing)

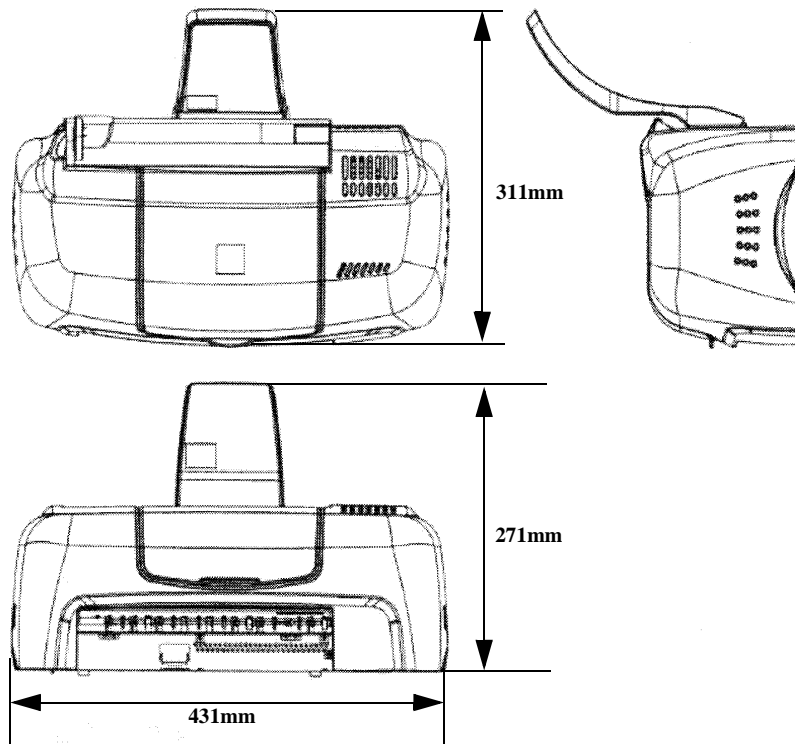

Figure 1-16. Stylus Color 580 Dimensions

WEIGHT

- Stylus Color 580: 3.0kg (without the ink cartridges)

1.5 Consumables and Options

CONSUMABLE

The consumable for this printer are following;

Table 1-6. Consumables

Classification	No.	Name
Consumables	S020187	Ink Cartridge (black)
	S020193	Ink Cartridge (color)

ENCLOSED PARTS

The following parts are enclosed in the Production.

Table 1-7. Enclosed parts

Enclosed Parts	Quantity
User's manual	1 (paper + CD-ROM)
Driver DISK	1(CD-ROM)\
Black ink cartridge	1
Color Ink cartridge	1
Power Code	1(220-240V version only) *1

NOTE: *1: On the 100-120V version product, the power cable is soldered on the PS board directly.

CHAPTER

2

OPERATING PRINCIPLES

2.1 Overview

This section describes the operating principles of the printer mechanism and electrical circuit boards. The Stylus COLOR 580 has only the following two circuit boards and does not have a control panel:

- Main board: C379MAIN-C (or C379MAIN-B) *1
- Power supply board: C367 PSB/PSE

NOTE: *1): C379MAIN-B board is used for the product in the first mass production and it will be changed to C379MAIN-C board at an early date. The major difference is that C379MAIN-C has one chip CPU which includes the ASCII function. This section describes the operation principle of C379MAIN-C.

2.1.1 Printer Mechanism

The printer mechanism for Stylus COLOR 580 is designed newly. But, the basic component of the printer mechanism is the same as the previous product. This printer consists of Print Head, Carriage Mechanism, Paper Feeding Mechanism, Paper Loading Mechanism, Ink System (Pump Mechanism, Cap Mechanism, and Carriage Lock Mechanism).

Like other EPSON ink jet printers, the Stylus COLOR 580 is equipped with two stepping motors; one for ASF, Paper feeding/ Pump mechanism, and one for CR mechanism. ASF unit uses rear entry front eject system. This ASF unit is also designed newly and a single LD roller loads the paper to the printer mechanism.

For the cap assembly, Stylus COLOR 580 uses a valveless mechanism; a new design for this model.

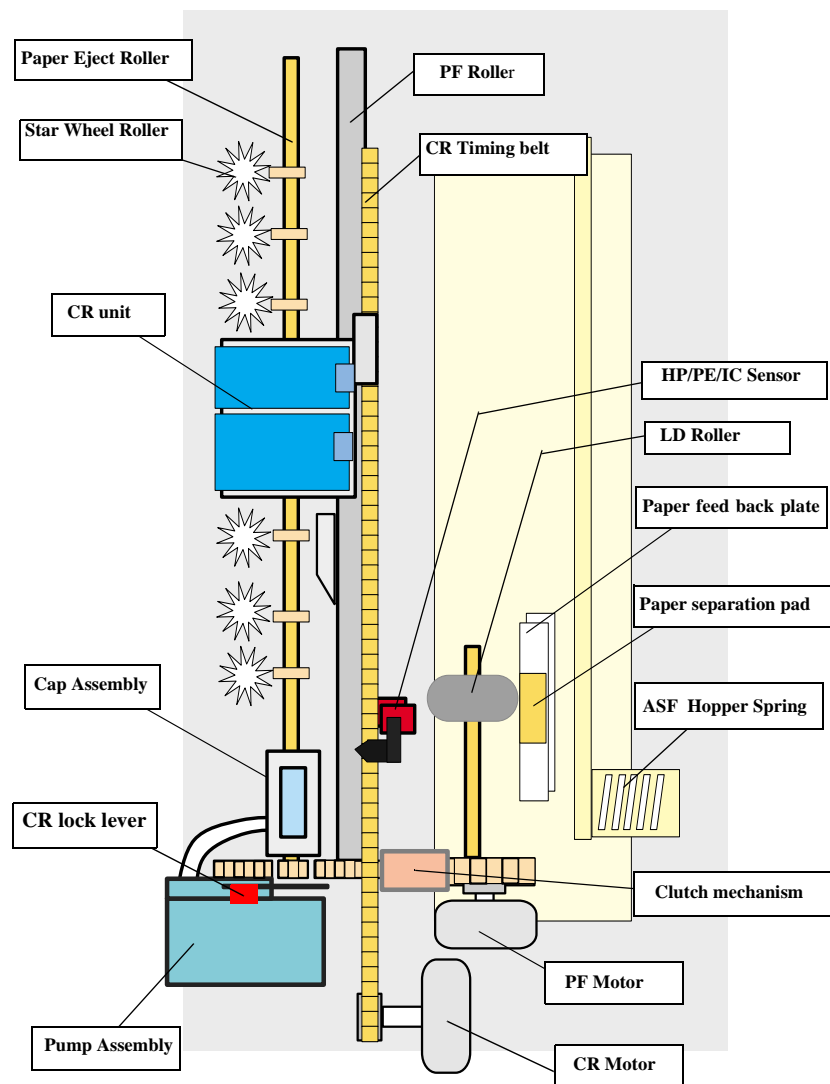

Figure 2-1. Printer Mechanism block diagram

2.1.2 Printhead

The print head uses a new developed U-CHIPS head and Stylus COLOR 580 can perform multiple shot printing and variable printing. Printheads nozzle configuration is as follows.

- 48 nozzles x 1 row: Black (nozzle pitch of the row: 1/120 inch)
- 45 nozzles x 1 row: Color (nozzle pitch of the row: 1/120 inch)
In the one row for the color, 15 nozzles are assigned for each yellow, magenta, cyan color)

The basic operating principles of the printhead, which plays a major role in printing, are the same as previous models; on-demand method which uses PZT (Piezo Electric Element). In order to uniform the amount of ejecting ink, the printhead has its own head ID (6 digits for this printhead) which adjust PZT voltage drive features. The printhead stores the head ID to EEPROM and generates appropriate PZT drive voltage to prevent amount of ink from varying by printheads.

Following explains printhead basic components.

- PZT**
PZT is an abbreviation of Piezo Electric Element. Certain amount of voltage expands and contracts PTZ. The drive wave generated on MAIN board drives PZT and PZT pushes the top cavity which has ink stored to discharge the ink from each nozzle on the nozzle plate.
- Ink Cavity**
The ink absorbed from the ink cartridge goes through the filter and then is stored temporarily in this tank called “cavity” until PZT is driven.
- Nozzle Plate**
The board with nozzle holes on the printhead surface is called Nozzle Plate.
- Filter**
When the ink cartridge is installed, if any dirt or dust around the cartridge needle is absorbed into the head, there is a great possibility of causing nozzle clog and disturbance of ink flow, and finally causing alignment failure and dot missing. To prevent this problem, a filter is set below the cartridge needle, where ink is filtered.

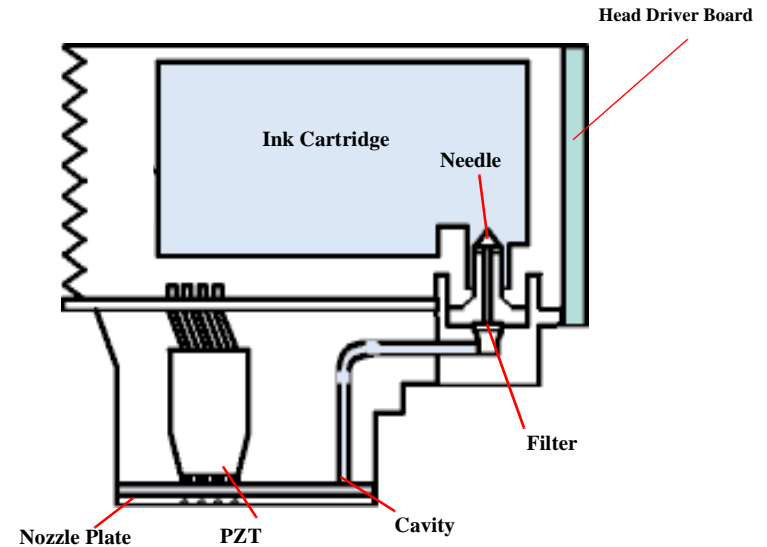

Figure 2-2. Printhead Sectional Drawing

2.1.2.1 Printing Process

This section explains the process in which the printheads of On-Demand inkjet printers eject ink from each nozzle.

1. **Normal State:**
When no printing signal is sent from PC, or no PZT drive voltage is applied, PZT does not change shape, therefore PZT does not squeeze the cavity. Ink pressure inside the cavity is kept normal. (Refer to Figure 2-3.)
- 2) **Ejecting State:**
When the print signal is output from the C379MAIN-C board, IC (Nozzle Selector) located on the printheads unit latches data once by 1-byte unit. An

appropriate PZT latched by the nozzle selector is pushed into the cavity by the common voltage applied from the main board. By this operation, ink stored in the cavity spurts out from nozzles. (Refer to Figure 2.1.2.2.)

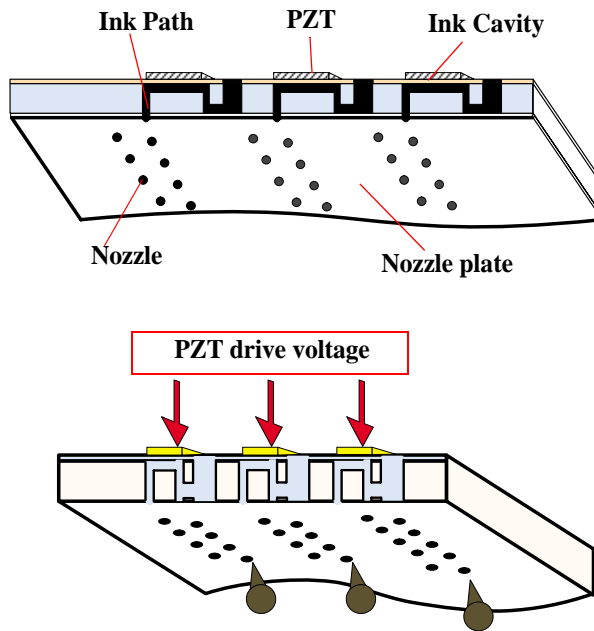

Figure 2-3. Printhead printing process

2.1.2.2 Printing Method

For print dot system, Stylus COLOR 580 has the following two kinds of printing modes.

- Multiple shot printing
- Variable dot printing

The above two printing modes are automatically selected depending on the media and the resolution setting of the printer driver. The following explains each printing mode.

- Multiple shot printing
This printing mode is developed to improve the print quality on plain paper or transparencies in low resolution. The multiple shot printing mode uses normal dot and the number of dot shots varies from 1 shot to maximum 4 shots depending on the print data to enable sharp image output even in a low resolution.
- Variable dot printing
This printing mode is developed to improve the print quality on exclusive paper. This mode is basically the same as variable dot printing mode used on other products /; micro dot, middle dot, and large dot compose this mode. Print dot size varies according to print data and this mode enables even sharper image output on exclusive paper.

2.1.3 Carriage Mechanism

The carriage mechanism consists of Carriage motor (CR motor), Carriage unit (including printhead), CR timing belt, CR guide shaft, CR guide frame, CR home & I/C detector (HP/PE/IC sensor) etc. The carriage mechanism moves the carriage back and forth according to the drive from the carriage motor. The following stepping motor is mounted to drive CR mechanism. (See the table below.)

Table 2-1. Carriage Motor Specification

Items	Specifications
Type	4-Phase/ 48-Pole PM Stepping motor
Drive Voltage	+42 V +/- 5% (DRV IC voltage)
Coil Resistance	10.8 Ω +/- 10% (per phase at 25 degree)
Inductance	15 mH +/- 20%(1KH 1VmA)
Drive Method	Bi-Polar drive
Driver IC	LB1845

The drive from CR motor is transferred to the CR unit via CR timing belt. And the CR home position is detected with the HP/PE/IC sensor. This sensor is available as CR HP detector only in the HP (home position) detection sequence & pump operation sequence. (not available in the paper feeding sequence for the CR HP detector because it is used for only PE sensor during the paper feeding sequence.) Moreover, unlike the previous products, this printer dose not have the PG adjustment mechanism (1.7mm).

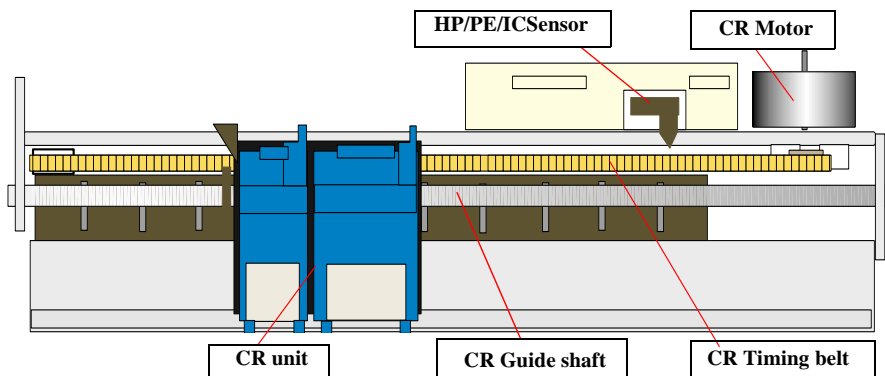

Figure 2-4. Carriage Mechanism (Top view)

CR home position is detected with the HP/PE/IC sensor and the detection plate molded in the CR unit as following figure. When the CR home position is detected with this sensor, HIGH signal is output to the CPU.

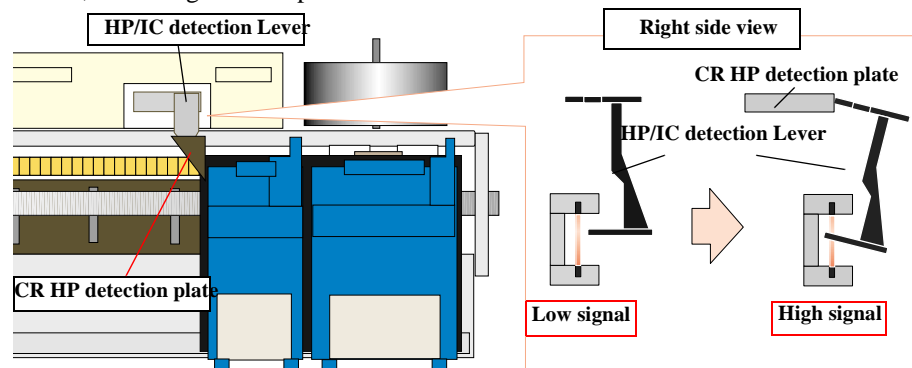

Figure 2-5. CR home position

Unlike the previous products, I/C detection sensor is not built in the CR unit. The I/C is detected with the HP/PE/IC sensor and the detection plate molded on the I/C cover as following figure. The I/C installation condition is monitored only when the CR unit moves to the I/C detection position (HP detection sequence). So, this sensor function is not available in the paper feeding sequence. When the I/C is not installed into the CR unit, HIGH signal is output to the CPU.

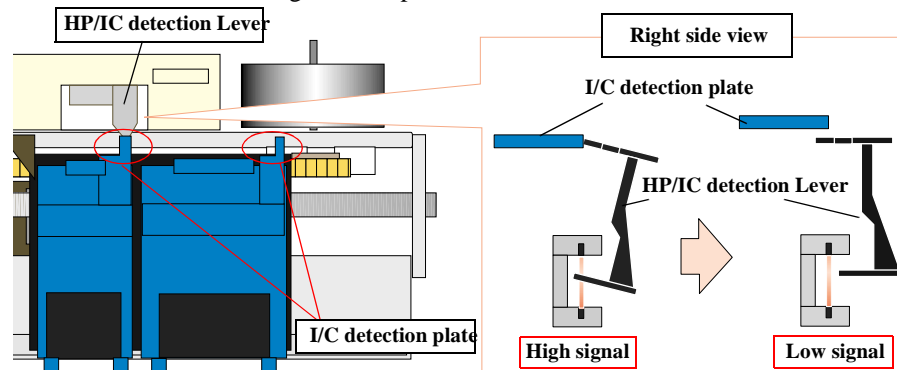

Figure 2-6. I/C detection position (

2.1.4 Paper Feeding Mechanism

The paper feeding mechanism consists of Paper feed motor (PF motor), PF roller, Paper eject roller, Star wheel roller, and so on. The paper feeding mechanism feeds paper loaded from ASF using the PF roller and Paper Eject Roller & Star wheel roller. For this mechanism, the PF motor mentioned in the right Table 2-2 is used on this product.

The drive of the PF motor is transfer to the PF roller and the Paper Eject Roller as following Figure 2-7. Following shows you how to transfer the PF motor drive to the PF roller and the Paper Eject Roller.

□ PF motor drive transmission path

PF Motor Pinion Gear (CW) Æ Combination Gear 8.4, 21.6 (CCW) Æ
 Combination Gear 9.6, 33.6(CW) Æ Spur Gear 15 (PF roller)(CCW) Æ Spur Gear
 34.2 (CW) Æ Spur gear 15 (CCW)

Table 2-2. PF Motor Specifications

Item	Description
Motor type	4-Phase/ 48-Pole PM Stepping motor
Drive voltage	+42 V +/- 5% (DRV IC voltage)
Coil Resistance	10 Ω +/- 10% (per phase)
Inductance	10.5 mH +/- 20%(1kHz 1Vrms)
Driving method	Bi-Polar drive
Driver IC	LB1845

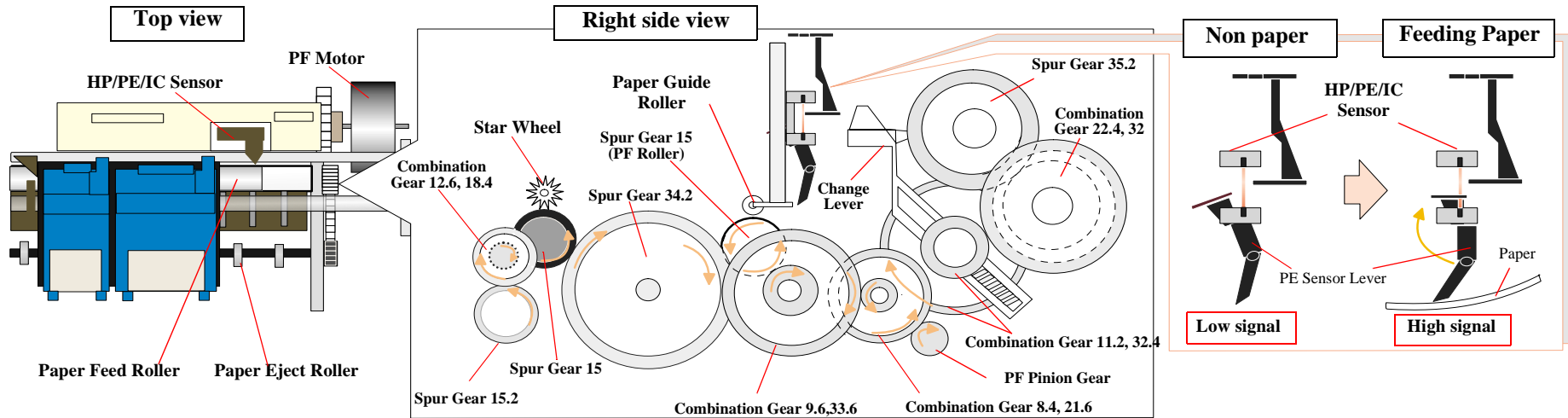

Figure 2-7. Paper Feeding Mechanism

Paper loaded from ASF is advanced by the following roller.

- Paper feed roller & Paper guide roller (assembled on the Top Frame) → Paper eject roller & Star wheel roller (assembled on the Paper eject frame).

Additionally, the top & end of the paper is detected with the HP/PE/IC sensor. In case the PE sensor dose not detect the paper in the paper loading sequence, the printer detects the “Paper out error”. If the paper is detected after complete the paper eject sequence, the printer detects the “Paper jam error”.

2.1.5 Paper Loading Mechanism (ASF Unit)

The Paper loading mechanism is positioned at the printer rear. The Paper loading mechanism loads paper at the ASF unit and feeds paper to the PF roller.

This ASF unit was designed newly for this product and consists of LD roller, Pad holder (Paper return plate), ASF Frame, Hopper, and so on.

For the major feature of this ASF unit, ASF HP sensor is not used and the single LD roller is built in the ASF unit.

Drive sent from the PF motor is always transmitted to the ASF unit side. But, the Change lever and the Clutch mechanism switch ON/OFF the PF motor drive to the LD roller with the motor rotational direction.

Drive from the PF motor is transmitted to the ASF unit as described below:

□ Switch the PF motor drive to ASF unit side

PF Motor pinion gear rotates CCW direction with a specific steps → Combination Gear 8.4, 21.6 (CW) → Combination Gear 11.2, 32.4 (CCW) → Change Lever rotates (CCW) → Release the Clutch mechanism lock position

Following Figure 2-8 shows you the switching path for PF motor drive to ASF unit side.

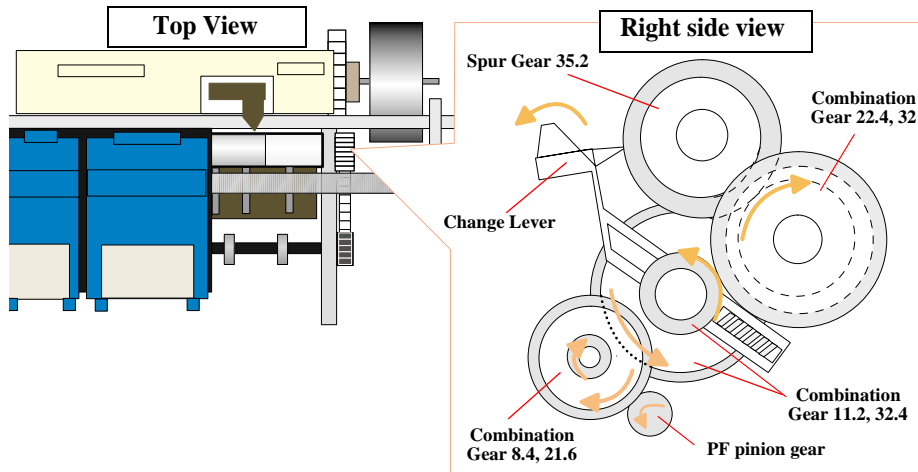

Figure 2-8. Switch the PF motor drive to ASF unit side

□ Transfer the PF motor drive to LD roller

PF Motor pinion gear rotates CW direction → Combination Gear 8.4, 21.6 (CCW) → Combination Gear 11.2, 32.4 (CW) → Change Lever rotates (CW) → Combination Gear 22.4, 32 (CCW) → Spur Gear 35.2 (CW) (include the clutch mechanism) → LD roller (CW).

Following Figure 2-9 shows the PF motor drive transmission path to the LD roller unit built in the ASF unit. The LD roller is assembled on the same shaft that the Spur gear 35.2 is assembled.

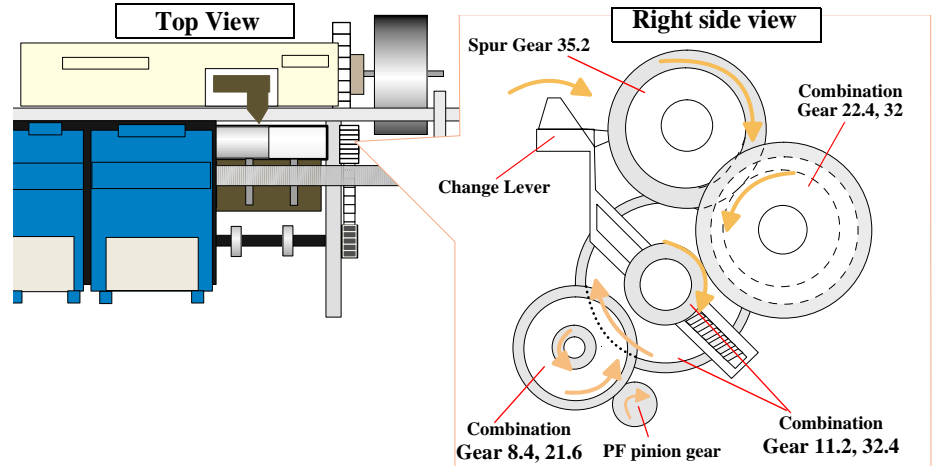

Figure 2-9. PF motor drive transmission path

When the PF motor torque is switched to the ASF unit side by the clutch mechanism, the function of the ASF mechanism varies depending on the rotational direction of the PF motor, as shown in the table below.

Table 2-3. ASF unit function & PF Motor rotational direction

Directions	Corresponding Functions
Clockwise (*1)	<ul style="list-style-type: none"> Picks up and loads paper
Counterclockwise (*1)	<ul style="list-style-type: none"> Release the DE lever & Clutch mechanism

(*1): The PF Motor rotational direction = seen from the right side of the printer.

□ Clutch Mechanism

Unlike the previous products, this product does not have an ASF HP sensor. Instead of the ASF HP sensor, the Change lever and the Clutch mechanism are used to detect the ASF home position. Following figures describe the mechanism.

NOTE:

The Clutch gear is molded on the back side of the Spur gear 35.2 such as Combination gear.

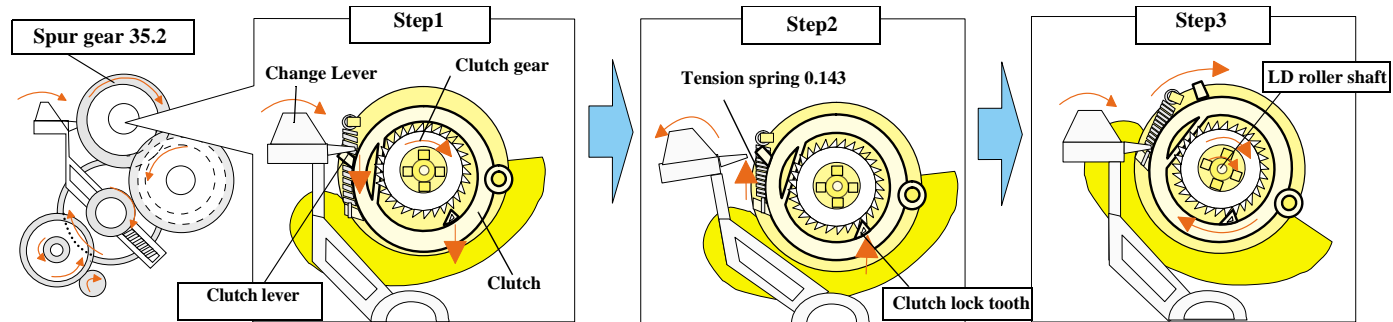

Figure 2-10. Disengage & Clutch mechanism

The Clutch mechanism transmits the PF motor drive to the LD roller shaft only when the Clutch gear rotates CW direction after the Change lever releases the Clutch lever. If the Clutch gear rotates CCW direction, the PF motor drive is not transmitted to the LD roller. This is due to the combination of the shape of the Clutch gear and the Clutch lock tooth such as described on the figure.

1. When the paper is advanced with the PF roller, the Change lever is set on the Clutch lever and the Clutch is pushed down as above Step1's figure. As the result, the Clutch gear (*1) is released from the Clutch lock tooth and the drive from the PF motor is not transmitted to the LD roller shaft.
2. When the PF pinion gear rotates CCW direction in the above Step2's figure, the Change lever moves to the left direction with the CCW rotation of Combination gear 11.2, 32.4. The Clutch turns back to the engagement position by the tension force of the Tension spring 0.143 and the Clutch gear is engaged with the Clutch lock tooth as above Step2's center figure.
3. When the PF pinion gear rotates CW direction in the above Step3's figure, the Change lever moves to the right direction with the CW rotation of the Combination gear 11.2, 32.4. And the drive from the PF motor is transmitted to the LD roller shaft via Clutch gear and Clutch lock tooth.

4. The LD roller shaft rotates about 360 degree and the Change lever pushes the Clutch lever and the PF motor drive is interrupted. This position is the ASF home position.

□ Paper Return Plate (Pad holder)

Unlike the previous products, the Paper return plate is built in the ASF frame instead of the Paper return lever. The Paper separation pad is also stacked on the plate. It works with the spring force of the Torsion spring 28.9 (mounted in the ASF frame) as following figure.

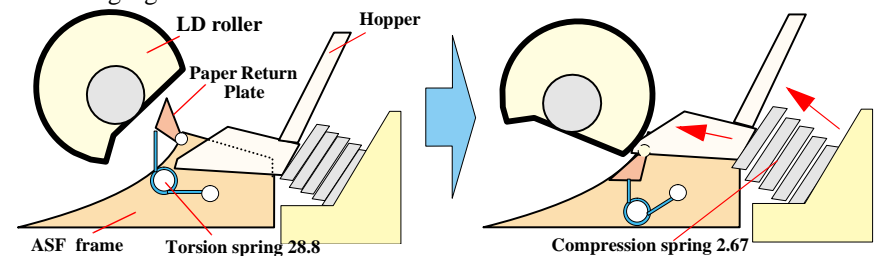

Figure 2-11. Paper Return Plate

The Paper return plate is set to return the paper to the paper stand-by position in the ASF unit when the ASF unit is in the standby mode. When the paper is fed with the LD roller, the Paper return plate is stored in the ASF frame by the LD roller.

Following figures show you the ASF paper loading sequence and the operation of the each mechanism.

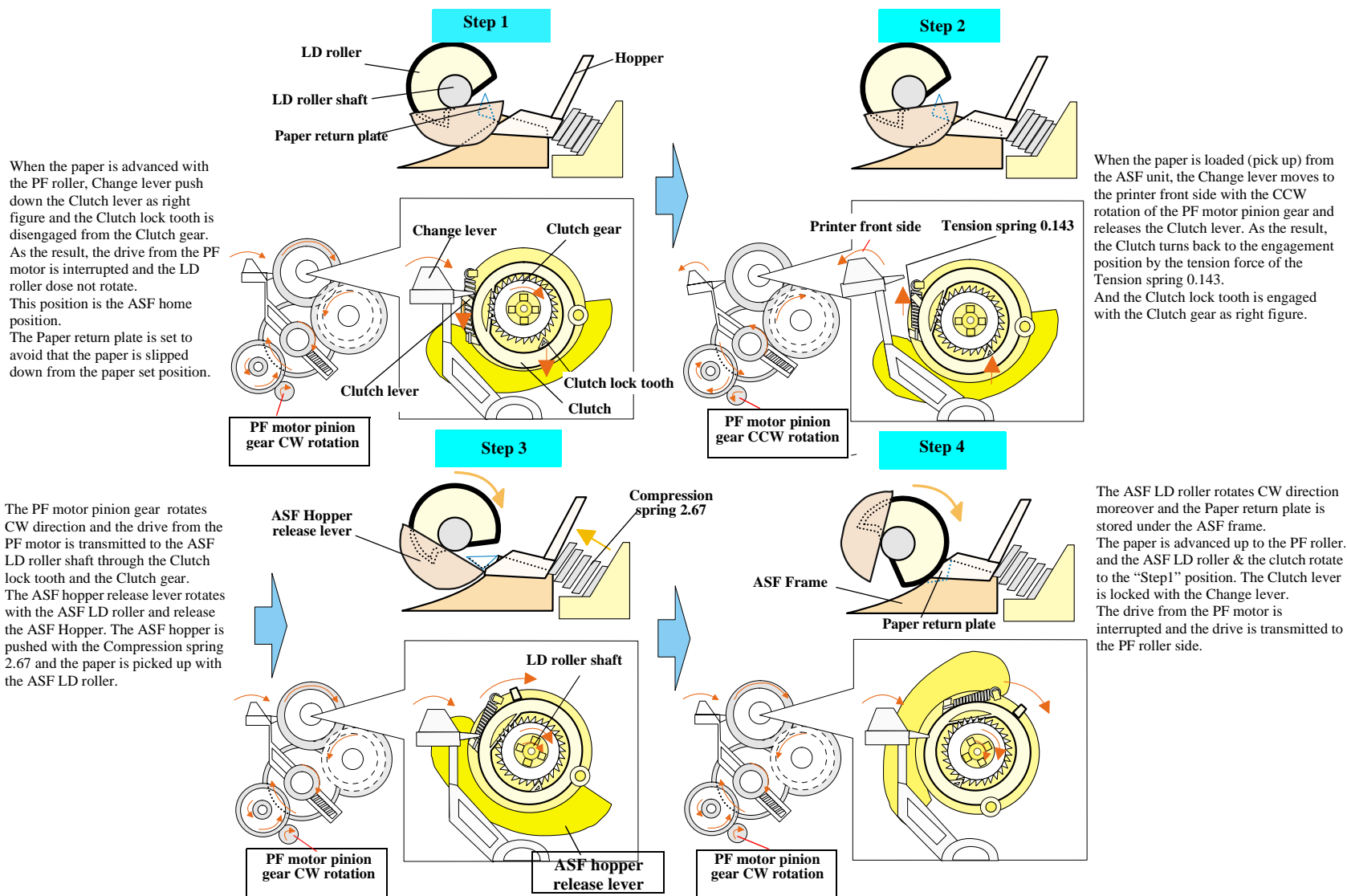

Figure 2-12. ASF Paper Loading Sequence

2.1.6 Ink System Mechanism

Ink system mechanism consists of pump unit (include the CR lock lever) and capping mechanism. Ink system mechanism drives the pump unit that presses cap to the printhead and ejects ink from ink cartridge, head cavity and cap to the waste ink pad.

2.1.6.1 Pump Unit & Wiper mechanism

The pump unit is driven by PF motor. PF motor drive is always transmitted to the paper feeding mechanism and pump unit through the following gears. Refer to the Figure 2-14.

PF Motor Pinion Gear (CW) → Combination Gear 8.4, 21.6 (CCW) → Combination Gear 9.6, 33.6 (CW) → Spur Gear 15 (PF Roller Gear) (CCW) → Spur Gear 34.2 (CW) → Spur gear 15 (CCW) → Combination Gear 12.6, 18.4 (CW) → Spur Gear 15.2 (CCW) (Pump unit)

The Pump unit and Wiper mechanism drives according to the PF motor rotational direction, as shown in the right table.

Table 2-4. PF motor rotational direction & Ink System Mechanism

Directions	Functions
Counterclockwise (*1)	<ul style="list-style-type: none"> Sets the wiper. Absorbs ink by the pump unit Set the CR lock lever
Clockwise (*1)	<ul style="list-style-type: none"> Resets the wiper.

(*1): The PF Motor rotational direction = seen from the right side of the printer.

Following figure shows the overview of the pump mechanism operation.

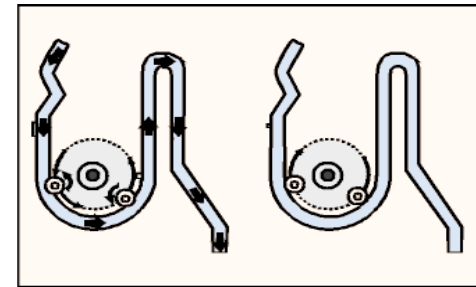

Figure 2-13. Pump mechanism

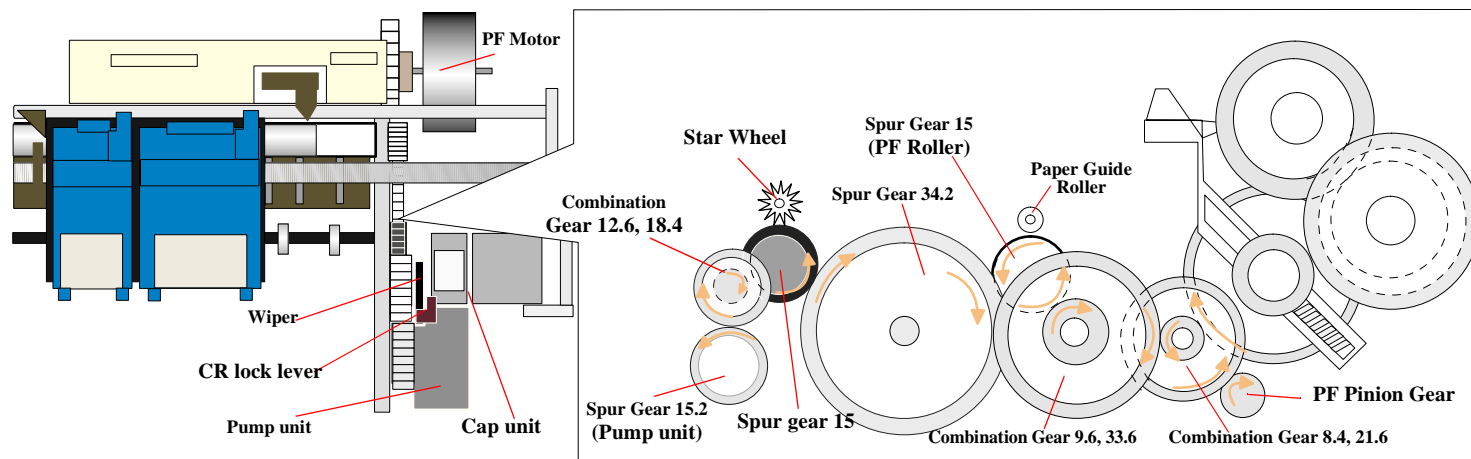

Figure 2-14. PF motor drive transmission path to the Pump unit

2.1.6.2 Capping Mechanism

The capping mechanism covers the printheads with the cap holder to prevent the nozzle from increasing viscosity when the printer is in stand-by mode or when the printer is off. This product has valveless cap system. Air valve function used for the previous models pumps and ejects ink only inside the cap by absorbing ink with the valve open. By opening the Air valve, the negative pressure is decreased and only the ink inside the cap is ejected. (the ink is not absorbed from Ink cartridge or head cavity.) But, valveless cap system, this operation is done out side of the capping area. The CR moves to left side of the Cap assembly and the pump absorbs the ink inside the cap.

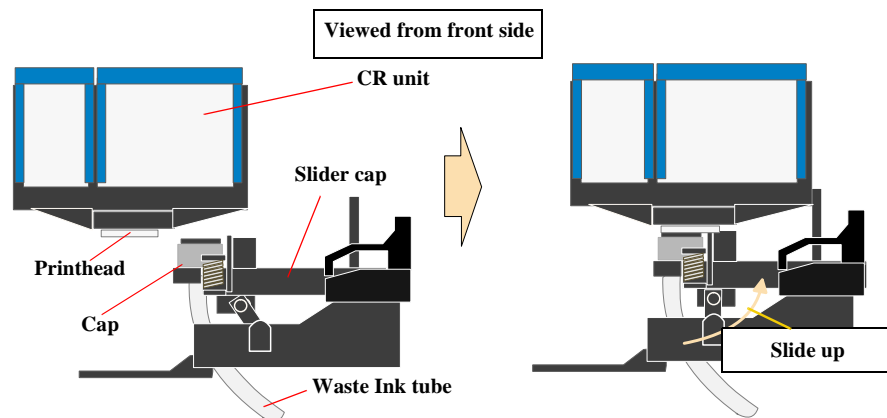

Figure 2-15. Cap Mechanism

2.1.7 Ink Sequence

□ Initial ink charge

After the product is purchased and the printer is turned on for the first time, the printer must be performed the initial ink charge and charges ink inside the head cavity. When the initial ink charge is completed properly, the printer releases the flag inside the EEPROM and no initial ink charge will be performed next time the power is turned on. Stylus COLOR 580 takes 110 seconds to complete the initial ink charge sequence and consume about half of the brand-new black ink cartridge.

□ Manual Cleaning

Unlike the previous models, the manual CL is available only through the utility included in the printer driver because this printer does not have a control panel. Stylus COLOR 580 provides three types of manual cleaning to clean air bubbled or clogged ink with viscosity or foreign substances. The following manual CL sequences can be executed by the utility included in the printer driver.

■ CL1

- Ink absorption
Black Ink: 0.21ml, Color Ink: 0.21ml
- Wiping operation
Wipes nozzle plate by the rubber part on the right half of the wiper.
- Flashing operation
Prevents color from mixing. Stabilizes ink surface inside the nozzle.

■ CL1'

- Ink absorption
Black Ink: 1.02ml, Color Ink: 1.02ml
- Wiping operation
Wipes nozzle plate by the rubber part on the right half of the wiper.
- Flashing operation
Prevents color from mixing. Stabilizes ink surface inside the nozzle.

■ CL2

- Ink absorption

Black Ink: 0.51ml, Color Ink: 0.51ml

-Wiping operation

Wipes nozzle plate by the rubber part on the right half of the wiper.

-Flashing operation

Prevents color from mixing. Stabilizes ink surface inside the nozzle.

The above mentioned manual CL is executed by performing nozzle check pattern and manual CL alternately. The cleaning order is CL1→CL1'→CL2→CL1. Like the previous products, CL1 is selected automatically and performed in case any print check is not executed between each manual CL. Additionally, if the manual CL is performed with over 5 pages printing cycle, CL1 is always selected and performed.

Additionally, if either black or color I/C is ink low or end condition, any manual cleaning is prohibited and it is displayed on the STM3.

□ Timer Cleaning

Unlike the previous product, this printer does not have Timer IC and Lithium battery which is used for the backup power source for Timer IC. So, this printer manages the printer off period or cleaning cycle by using the following method.

The printer driver sends the time command to the printer every D4 command transportation. The time command is generated based on the PC's timer and it consists of year and month, date, hour, minutes, second. As soon as the printer receives the time command from the printer driver, it is compared with the latest cleaning time which is stored in the 6A<H>, 6B<H> address of the EEPROM. And if the timer cleaning period is over the specific period, the printer performs the timer cleaning automatically and stores the time command in the 6A<H>, 6B<H> address of the EEPROM. In case the timer cleaning period is not over the specific period, the time command is not stored in the EEPROM and it is abandoned. Maximum 0.48ml of the ink is consumed in the Timer cleaning. (0.24ml of each black and color ink is consumed.)

□ Flashing

This printer performs the following two kinds of the Flashing for the following purpose.

■ Periodical Flashing

This is done to avoid the increment of both ink's viscosity in the printhead nozzle during the continuous printing and the specific small amount of the ink is ejected in the cap based on the periodical flashing timer.

■ Periodical large amount Flashing

This is done to avoid the increment of black ink's viscosity in the print head nozzle during the continuous printing and large amount of the ink is ejected in the cap based on the periodical large amount flashing timer.

2.1.8 Printing mode

The print resolution and printing method are determined automatically by setting the media type and print quality (It is able to set by slider bar) in the printer driver as following table. Following table show you the detail setting in the “Auto” mode.

Table 2-5. Printing mode for Color mode

Print media	Slide bar	Resolution	Print mode	High Speed*1	Micro weave	Dot size*2
Plain paper	Speed	360 x 120	Economy	ON	ON	ND-3dot
	Default	360 x 360	Normal 360	ON	ON	MSD2
	Quality	720 x 720	Photo 720	ON	ON	VSD
Photo Quality ink jet paper	Default	360 x 720	Fine 360	ON	ON	MSD2
	Quality	720 x 720	Photo 720	OFF	ON	VSD
Photo paper	Speed	360 x 720	Fine 360	ON	ON	MSD2
	Default	720 x 720	Photo 720	OFF	ON	VSD
	Quality	1440 x 720	Photo1440	OFF	ON	VSD
Ink Jet transparencies	N/A	360 x 360	Normal 360	OFF	ON	MSD2

NOTE: *1: High speed means Bi-directional printing.
 *2: ND means Normal dot. MS means Multi Shot Dot.
 VSD means Variable Shot dot.

Table 2-6. Printing mode for Black mode

Print media	Slide bar	Resolution	Print mode	High Speed*1	Micro weave	Dot size*2
Plain paper	Speed	360 x 120	Economy	ON	ON	ND-3dot
	Default	480 x 240	Normal 240	ON	ON	MSD1
	Quality	360 x 720	Fine 360	ON	ON	MSD2
Photo Quality ink jet paper	Default	360 x 720	Fine 360	ON	ON	MSD2
	Quality	720 x 720	Photo 720	OFF	ON	VSD
Photo paper	Speed	360 x 720	Fine 360	ON	ON	MSD2
	Default	720x720	Photo 720	OFF	ON	VSD
	Quality	1440 x 720	Photo1440	OFF	ON	VSD
Ink Jet transparencies	N/A	720 x720	Photo 720	OFF	ON	MSD2

NOTE: *1: High speed means Bi-directional printing.
 *2: ND means Normal dot. MS means Multi Shot Dot.
 VSD means Variable Shot dot.

2.2 Electrical Circuit Operating Principles

The electric circuit of the Stylus COLOR 580 consists of the following boards.

- Main board: C379MAIN-C Board (C379MAIN-B Board*1)
- Power supply board: C367 PSB/PSE Board

NOTE: C379MAIN-B board is used for the product in the first mass production and it will be changed to C379MAIN-C board at an early date. The major difference is that C379MAIN-C has one chip CPU which include the ASCI function. This section describes the operation principle of C379MAIN-C

This section provides operating principles of C379MAIN-C Board and C367 PSB/PSE Board. Refer to Figure 2-16 for the major connection of the each boards and their roles.

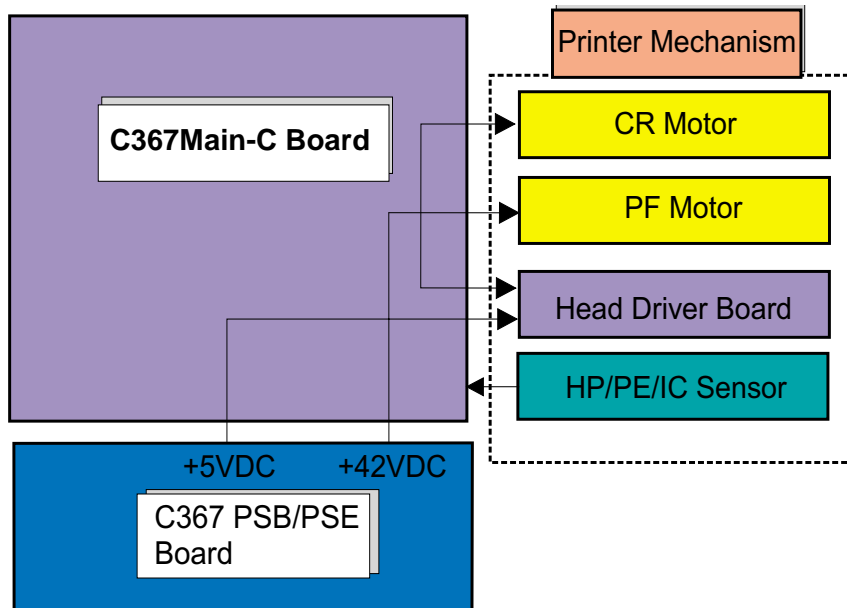

Figure 2-16. Electric Circuit

2.2.1 C367 PSB/PSE board

The power supply boards of Stylus COLOR 580 use a RCC (Ringing Chalk Converter) circuit, which generates +42VDC for drive line and +5VDC for logic line to drive the printer. The application of the output voltage is described below.

Table 2-7. Application of the DC Voltages

Voltage	Application
+42VDC	<ul style="list-style-type: none"> • Motors (CR Motor, PF Motor) • Printhead common voltage • Printhead nozzle selector 42V drive voltage
+5VDC	<ul style="list-style-type: none"> • C379MAIN control circuit logic • Sensor

This printer dose not have the Power SW. So, the printer is turned on when the AC cable is connected to the AC inlet. If the AC cable is disconnected from the AC inlet, this power supply circuit supply 5 voltage for approximately 70us to keep the logic circuit.

AC voltage input from AC inlet first goes through filter circuit that removes high frequency components and is then converted to DC voltage via the rectifier circuit and the smoothing circuit. DC voltage is then lead to the switching circuit and FET Q1 preforms the switching operation. By the switching operation of the primary circuit, +42VDC is generated and stabilized at the secondary circuit. This +42VDC generated by the secondary circuit is converted to +5VDC by the chopping regulator IC of the secondary circuit.

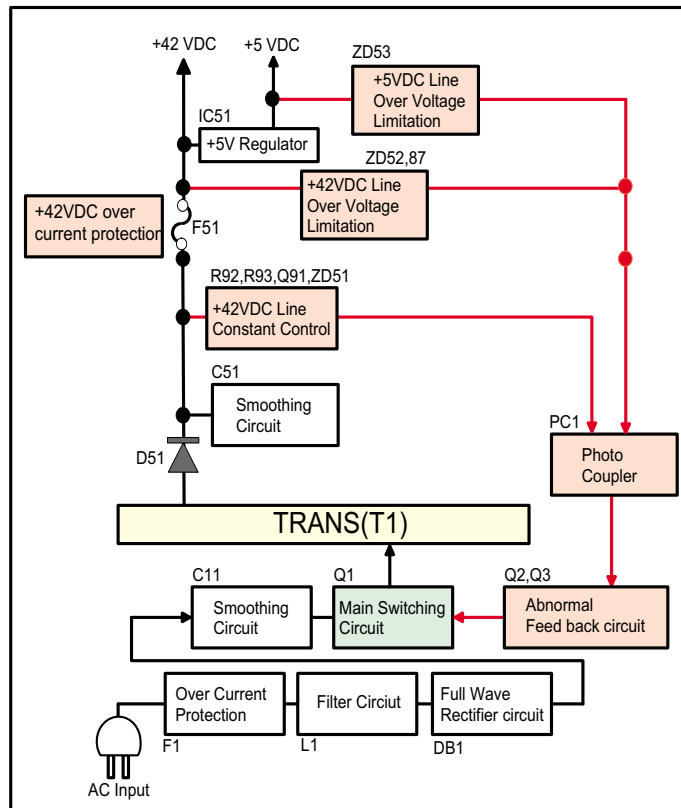

Figure 2-17. C367PSB/PSE Board Block Diagram

The C367 PSB/PSE board has the various control circuits to stop voltage output if a malfunction occurs on the power supply board or the main board while the printer mechanism is on duty. Following explains each control and protection circuit.

- +42V line constant voltage control circuit:
The output level of +42V line is monitored by a R92, R93, Q91, ZD51.
When + 42V line reaches about 42.5V, ZD51 has a continuity with and PC1 start the operation via Q91. Consequently, Q1 switching operation is controlled by this circuit to stabilize the 42V line.

- +42Vline over voltage protection circuit:
The output voltage line is monitored by ZD52,ZD87. If the output level of the voltage level of +42DC line exceeds +48V, this circuit stops the operation of the switching FET Q1 via PC1, Q82, Q83 and prevents high voltage from applied to the secondary side
- +42Vline over current protection circuit:
The output voltage is monitored by the F51. When the abnormal current is detected by F51, F51 is fused and cut off the +42V line output to the Main board
- +5V line constant voltage control circuit/+5V line over current protection circuit:
The output level of the +5VDC line voltage is monitored by the regulator IC51. If abnormal voltage is detected, the information is fed back to the internal comparator.
- +5V line over voltage protection circuit:
The output voltage level of the +5V line is monitored by ZD53.
If the output level of the voltage level of +5DC line exceeds +7V, this circuit stops the operation of the switching FET via PC1, Q82, Q83 and prevents high voltage from applied to the secondary side.

2.2.2 C379MAIN-C Board

The printer mechanism is controlled by C379MAIN-C. On this MAIN board, 3.3V regulator IC is not mounted and all IC is driven with 5.0 V. See Figure for the C379MAIN-C board block diagram.

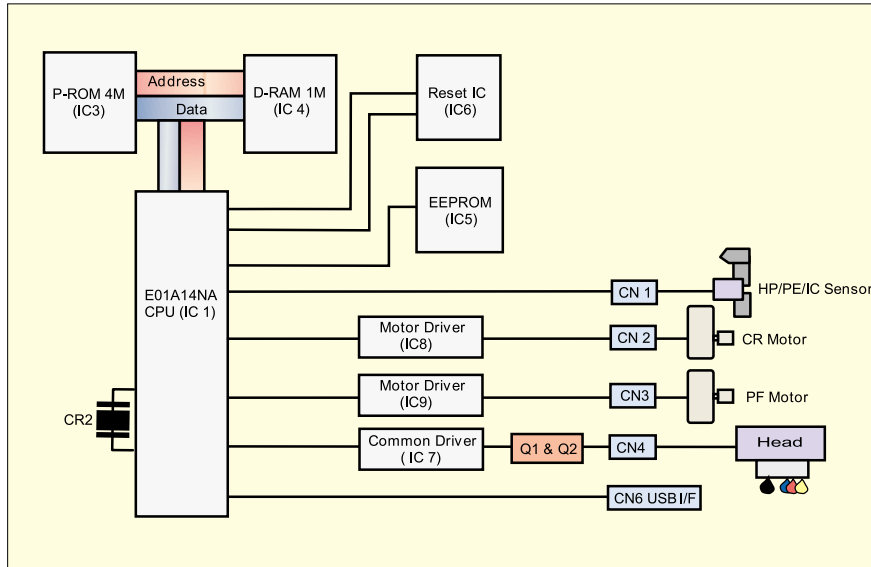

Figure 2-18. Block Diagram for the C379MAIN-C Board

Following shows you the major characteristic of this main board.

- Timer IC & Lithium battery are not mounted
Unlike the previous products, the Timer IC and the Lithium battery are not mounted on the Main board. So, this product perform the Power-on cleaning or Timer cleaning based on the time command which is sent from the printer driver. As for the detail, refer to the 2.1.7 Ink Sequence.
- D-RAM
1Mbit D-RAM is mounted on the Main board.
- One CPU controls the all function on the main board.

2.2.2.1 Main elements

Table 2-8 shows the function of the each main elements on C379MAIN-C.

Table 2-8. Main Elements

IC	Location	Function
CPU E01A19NA	IC1	16bit CPU mounted on the MAIN board is driven by clock frequency 24MHz and controls the printer.
PROM	IC3	<ul style="list-style-type: none"> • Capacity 4MB, Bus= 16 bit • Program for CPU
RAM	IC4	Bus= 16 bit, 1Mbit DRAM
AT93C46	IC5	1kbit EEPROM <ul style="list-style-type: none"> • Default value setting • Parameter backup
LA5623M	IC6	Reset IC <ul style="list-style-type: none"> • For +5V; reset when +4.2V is detected • For +42V, reset when +33.2 is detected
E09A17RA	IC7	Head drive control HIC <ul style="list-style-type: none"> • Generates head common voltage.
LB1845	IC8	CR motor drive IC
LB1845	IC9	PF motor drive IC

2.2.2.2 Printhead Driver Circuit

The printhead drive circuit consists of the following two components:

- Head common driver circuit
(Common driver IC7 & Wave amplifier transistor Q1, Q2)
- Nozzle selector IC on the printhead driver board.

The common driver (IC7) generates a reference drive waveform according to the output signals from the CPU (IC1). The reference drive waveform is amplified by the transistors Q1 and Q2 and then transferred to the nozzle selector IC on the print head circuit board. Print data is converted to serial data by the CPU and then sent to the nozzle selector IC on the print head circuit board. Based on the serial data, the nozzle

selector IC determines the nozzles to be actuated. The selected nozzles are driven by the drive waveforms generated by the common driver. See Figure 2-19 for the printhead driver circuit block diagram.

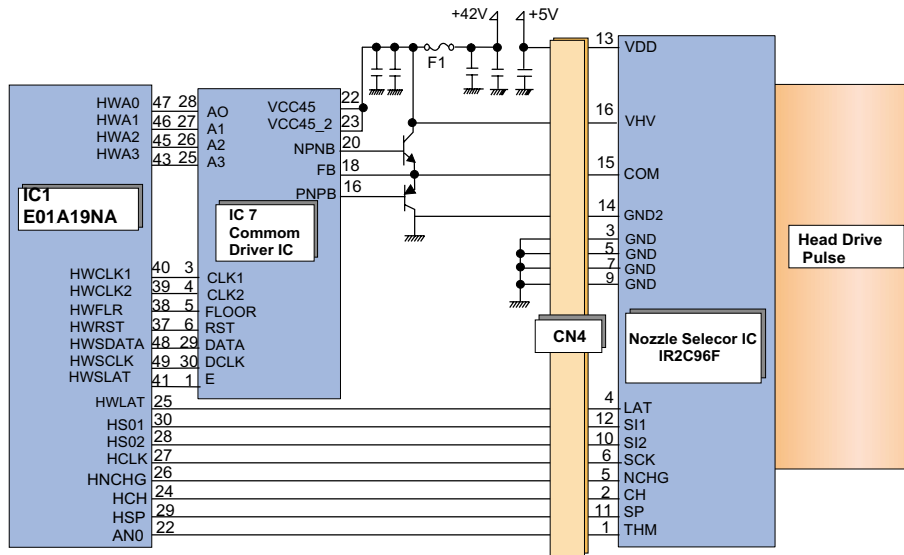

Figure 2-19. Printhead Driver Circuit

- Head common driver circuit

The reference head drive waveform is generated in the common driver (IC7) based on the following 11 signal lines output from the CPU (IC1); A0-A3, CLK1, CLK2, FLOOR, RST, DATA, DCLK, and E.

Based on the DATA signal output from the CPU (IC1), the original data for the head drive waveform is written in the memory in the common driver (IC7). The addresses for the written data are determined by the A0 - A3 signals, and, of among, data used to determine the waveform angles is selected and appropriate head driver waveform is generated. Generated head drive waveform is transferred to nozzle selector IC on the head driver board and applied to the nozzle PZT specified by nozzle selector IC.
- Head nozzle selector circuit

Printing data are allocated to the two rows, the number of the head nozzle rows, and converted into serial data by the CPU (IC1). Then the converted data is transferred to the nozzle selector IC through the two signal lines (SI0 to SI2). Data transmission from the CPU to the nozzle selector synchronizes with the SCK clock signal and the LAT signal. Referring to the transferred data, nozzles to be activated are selected, and the PZTs of the selected nozzles are driven by the drive waveform output from the head common driver.

2.2.2.3 PF Motor (PF/ PUMP/ ASF Motor) Driver Circuit

The motor driver IC (IC9) on the MAIN board drives PF motor. This product uses 4-phase 48-pole hybrid type stepping motor and performs constant current bi-polar drive.

CPU (IC1) converts PF motor phase control signal to LB1845 micro step drive form and outputs to motor driver IC (IC9) LB1845 from port 12, 17. Based on this signal, IC9 determines the phase mode.

The current value on each phase is determined by CPU (IC1) and outputs from port 13, 14, 15, 16, to driver IC (IC9). Motor driver IC generates motor driver waveform based on these input signals and controls the motor. If the printer dose not receive any data from PC for 5 minutes, CPU set the motor drive current to 0 via port 13, 14,15,16 and the motor drive is turned off to save the power consumption.

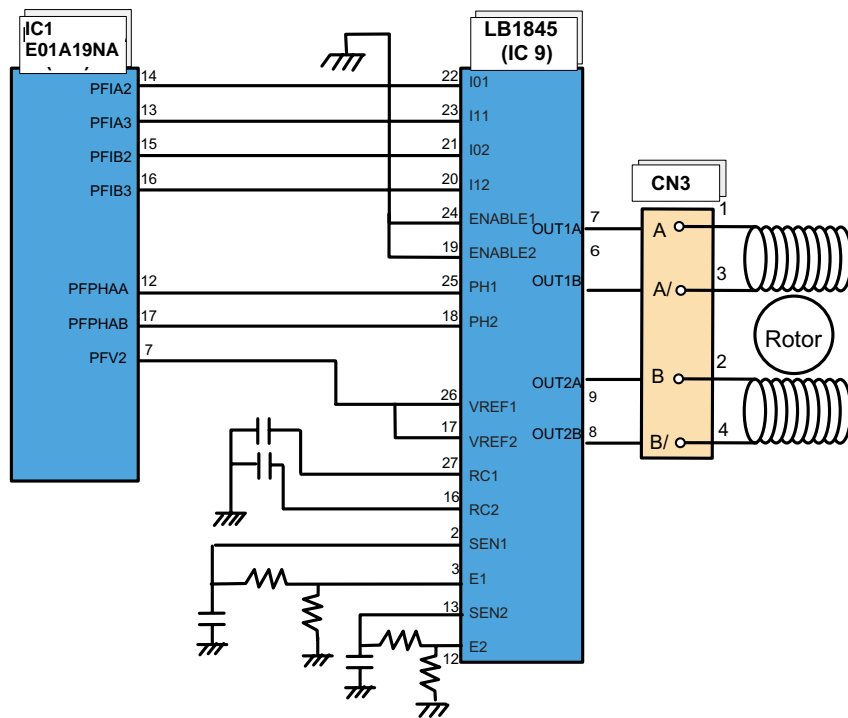

Figure 2-20. PF Motor Driver Circuit Block Diagram

2.2.2.4 CR Motor Driver Circuit

The motor driver IC (IC8) on the MAIN board drives PF motor. This product uses 4-phase 48-pole hybrid type stepping motor and performs constant current bi-polar drive.

CPU (IC1) converts PF motor phase control signal to LB1845 micro step drive form and outputs to motor driver IC (IC8) LB1845 from port 139, 144. Based on this signal, IC8 determines the phase mode.

The current value on each phase is determined by CPU (IC1) and outputs from port 140, 141, 142, 143, to driver IC (IC8). Motor driver IC generates motor driver waveform based on these input signals and controls the motor. If the printer dose not receive any data from PC for 5 minutes, CPU set the motor drive current to 0 via port 140, 141,142,143 and the motor drive is turned off to save the power consumption.

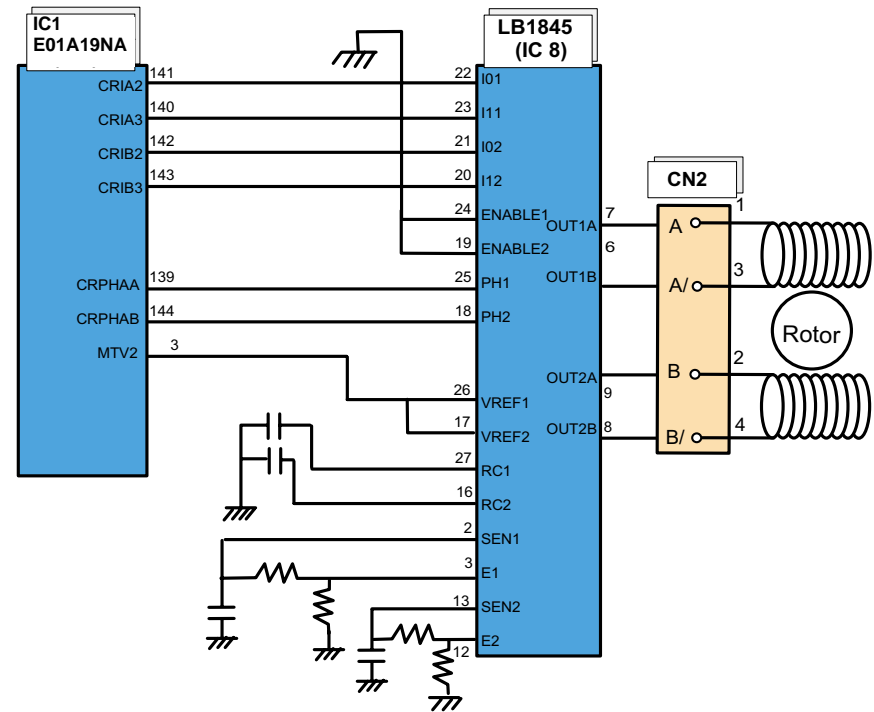

Figure 2-21. CR Motor Driver Circuit Block Diagram

2.2.2.5 Reset Circuit

Reset circuits consist of the rest IC (IC6). Reset circuits are mounted on the MAIN board to monitor the two voltages: +5V for the logic line and +42V for the drive line. When each circuit detects abnormality on the corresponding line, it outputs a reset signal to reset CPU (IC1). This function is necessary to prevent the printer from operating abnormally. This IC monitors both +5V and +45 lines but can reset them independently. The reset circuits outputs reset signal when +5V line becomes 4.2V or lower or +42V line becomes 33.2V or lower.

Unlike the previous products, the timer IC is not built in the reset IC and the Lithium battery also is not equipped on the main board.

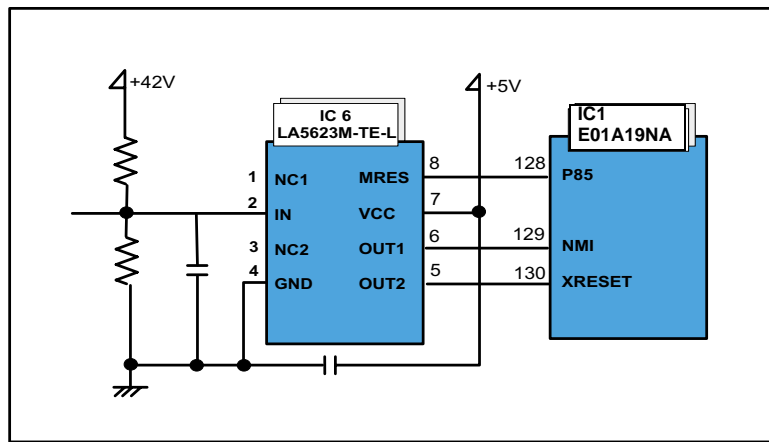

Figure 2-22. Reset Circuit Block Diagram

Main signal lines are explained below;

- OUT1: Interrupt signal
- OUT2: Reset line
- IN: +42V line monitoring line
- VCC: +5V line monitoring line

2.2.2.6 EEPROM Control Circuit

Since EEPROM is nonvolatile memory, it keeps written information if the printer power is turned off. When the printer is turned ON, CPU (IC1) reads data from EEPROM (IC5) and when the power is turned OFF it stores data to EEPROM.

Information stored in EEPROM is listed below.

- Various ink counter (I/C consumption counter, waste pad counter, etc.)
- Mechanical setting value (Head ID, Bi-D adjustment, USB ID, etc.)

See Table 7-7, “EEPROM Address Map,” on page 132 that provides detailed information on the values stored in EEPROM.

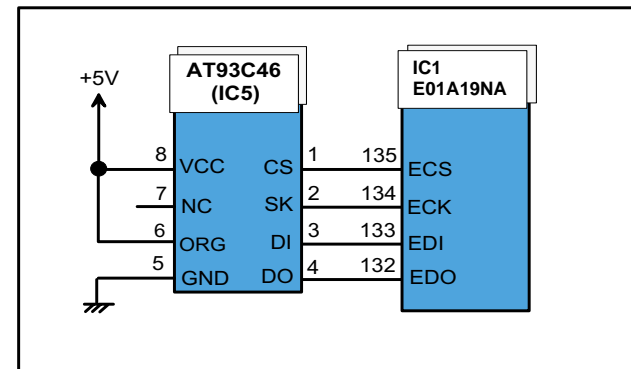

Figure 2-23. EEPROM Circuit Diagram

EEPROM is connected to CPU with 4 lines and each line has the following function.

- CS: Chip selection signal
- CK: Data synchronism clock pulse
- DI: Data writing line (serial data) at power off.
- DO: Data reading line (serial data) at power on.

2.2.2.7 Sensor Circuit

C379MAIN-C is equipped with the following two sensors to detect the status of the printer. Unlike the previous product, ASF HP sensor is not equipped on the ASF and the ASF HP is determined with the clutch mechanism (2.1.4 Paper Feeding Mechanism).

□ HP/PE/IC Sensor

This sensor uses photo interrupter method and detects the following three status. The photo interrupt component and two detection levers consists of this sensor.

■ CR home position

The CR home position is detected on the right edge of the CR shaft with the HP/PE/IC sensor during the power on sequence. In case the CR home position is detected in the power on sequence, this sensor outputs HIGH signal to the CPU.

When the LOW signal is output to the CPU in the detection position, the CR unit is out of home position.

■ Ink cartridge installation condition.

When the printer is powered on, the CR unit moves to the left side with the specific steps. And in case the plate molded on the Ink cartridge cover push the sensor detection lever, the sensor detects that the ink cartridge is not installed in the CR unit and outputs HIGH signal.

When the ink cartridge is installed in the CR unit, the plate molded on the ink cartridge cover dose not contacts with the sensor detection lever and the LOW signal is outputs to the CPU. The Ink cartridge installation condition is monitored in the ink cartridge replacement sequence also.

■ Paper Top & End position

When the Paper is in the paper path, this sensor outputs the HIGH signal.

When the Paper is not in the paper path, this sensor outputs the LOW signal.

This status is always monitored during the printer is in the power on status with this sensor.

□ Thermistor (THM)

The thermistor is attached directly on the printhead driver board. It monitors the temperature around the printhead and determines the proper head drive voltage according to the ink viscosity that varies by the temperature. This information is fed back to the CPU analog port. When the temperature rises, the head drive circuit lowers the drive voltage: When the temperature lowers, the head drive circuit rises the drive voltage.

The block diagram for the sensor circuit is shown below

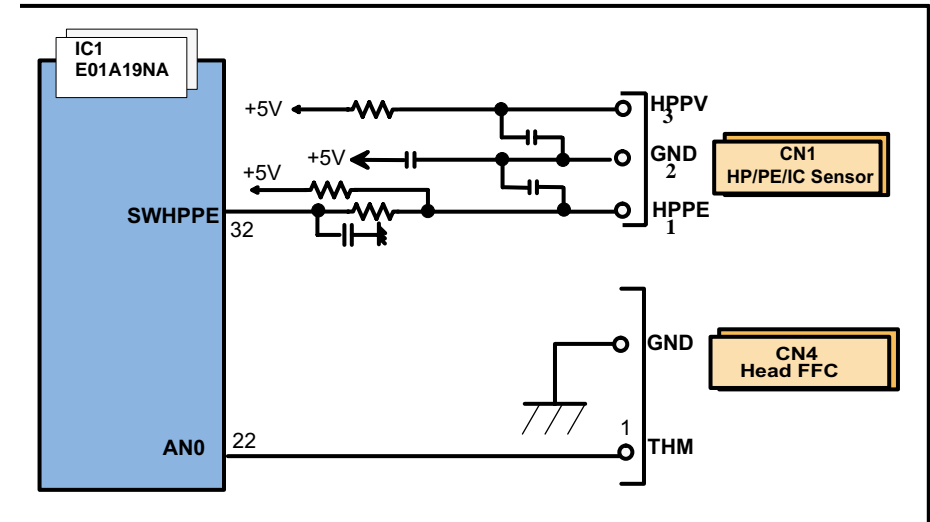

Figure 2-24. Sensor Circuit Diagram

CHAPTER

3

TROUBLESHOOTING

3.1 Overview

This chapter describes how to identify troubles in two levels: unit level repair and component level repair. Refer to the flowchart in this chapter to identify the defective unit and perform component level repair if necessary. This chapter also explains motor coil resistance, sensor specification and error indication.

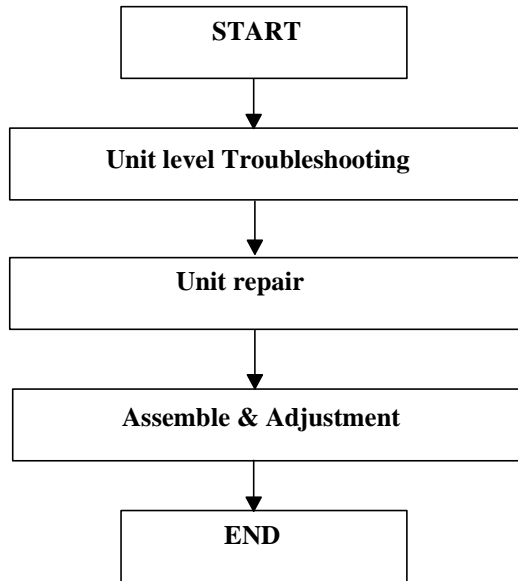

Figure 3-1. Troubleshooting Flowchart

Table 3-1. Motor, Coil Resistance

Motor	Location	Check Point	Resistance
CR Motor	CN2	Pin 1 and 3 Pin 2 and 4	10.8 Ohms ± 10% (at 25 °C/ phase)
PF Motor	CN3	Pin 1 and 3 Pin 2 and 4	10 Ohms ±10% (at 25 °C/ phase)

Table 3-2. Sensor Check Point

Sensor Name	Check Point	Signal Level	Switch Mode
HP/PE/IC Sensor	CN1/Pin 1 and 2	Less than 0.7V	Off <ul style="list-style-type: none"> • Out of HP range • No paper • Detect the I/C
		More than 2.4V	On <ul style="list-style-type: none"> • Within HP range • Detect the paper • Not detects the I/C
Thermistor (THM)	TH1 (on the Head driver board)	Analog signal	10 K (at 24 °C)

Table 3-3. Error Indication

Condition	Status Monitor 3 Indication	Generic Remedy
<ul style="list-style-type: none"> No Paper Paper is not loaded correctly 	 <p>Figure 3-2. Paper is not loaded correctly</p>	<ol style="list-style-type: none"> 1) Reload the paper, then click the “Continue” button. 2) If you want cancel the print job, click the “Cancel” button.
<ul style="list-style-type: none"> Paper Jam 	 <p>Figure 3-3. Paper Jam</p>	<ol style="list-style-type: none"> 1) Click the “Eject” button to eject any jammed paper. 2) If the paper is still jammed inside the printer, click the “Stop” button to cancel the print job. Then, open the printer cover and remove the jammed paper.

Table 3-4. Error indication

Condition	Status Monitor 3 Indication	Generic Remedy
<ul style="list-style-type: none"> Ink Out 	 <p>Figure 3-4. Ink out</p>	<ol style="list-style-type: none"> 1) Click the “How to” button and replace the I/C by following the procedure.
<ul style="list-style-type: none"> Ink Low 	 <p>Figure 3-5. Ink low</p> <p><i>NOTE: If this error is indicated on the monitor, you can continue the printing until the I/C becomes ink out condition. However, the head cleaning operation can not be done so that the remaining ink is low condition. Refer to Figure 3-6 on the next page.</i></p>	<ol style="list-style-type: none"> 1) Click the “How to” button and replace the I/C by following the procedure.

Table 3-5. Error indication

Condition	Status Monitor 3 Indication	Generic Remedy
<ul style="list-style-type: none"> Head cleaning can not be completed. 	 <p>Figure 3-6. Head cleaning caution</p>	<p>Click “Yes” button and replace the I/C by following the procedure.</p>
<ul style="list-style-type: none"> Head alignment (bi-d) was not performed. 	 <p>Figure 3-7. Print head alignment was not performed</p> <p><i>NOTE: This error message is NOT indicated on Stylus COLOR 580. Even if the Bi-d Adjustment is not done, Printer driver ignore the status.</i></p>	<p>Use the Print head alignment utility on the printer driver utility menu to align the print head.</p>

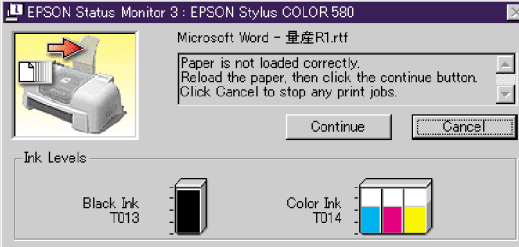
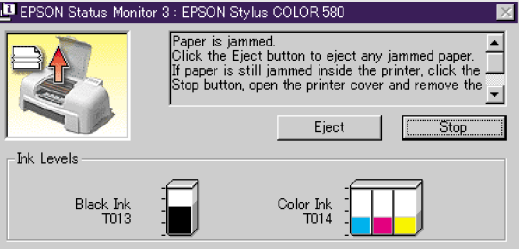
Table 3-6. Error indication

Condition	Status Monitor 3 Indication	Generic Remedy
<ul style="list-style-type: none"> Communication Error 	 <p>Figure 3-8. Communication error</p>	<ol style="list-style-type: none"> 1) Check the correct printer driver is selected in the printer setting. 2) Check the USB I/F cable is connected correctly. 3) Disconnect the AC cable and connect it again.
<ul style="list-style-type: none"> General Error 	 <p>Figure 3-9. General error</p>	<p>Motors or circuit boards may be broken. Find out the failure parts by referring to the “Unit level troubleshooting”.</p>

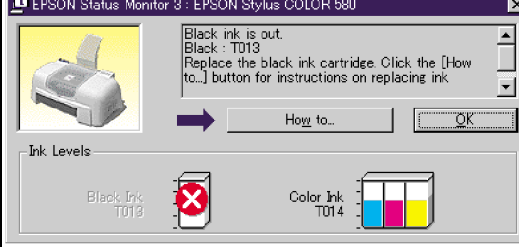
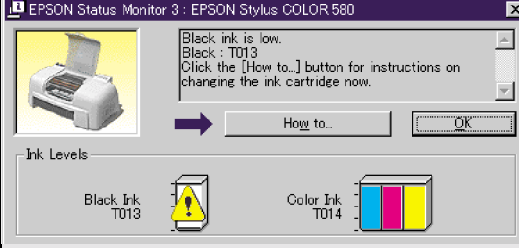
Table 3-7. Error Indication

Condition	Status Monitor 3 Indication	Generic Remedy
<ul style="list-style-type: none"> Waste Ink pad overflow Error. 	 <p>Figure 3-10. Waste Ink Error</p>	<p>Replace the Waste drain ink pad with new one and reset the Waste drain ink pad counter (Protection counter A) by using the Service Adjustment program.</p>

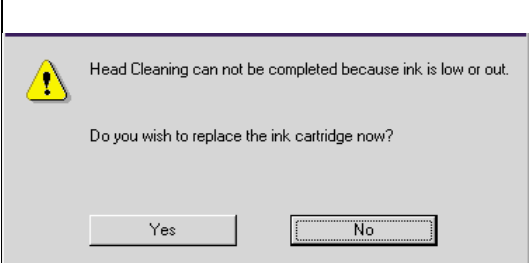
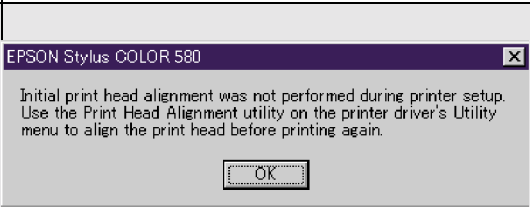
3.2 Unit Level Troubleshooting

You can identify the troubles, using the checklist in this section and then find defective parts. When you find out defective parts, replace them by referring the Chapter 4 “Disassembling.”

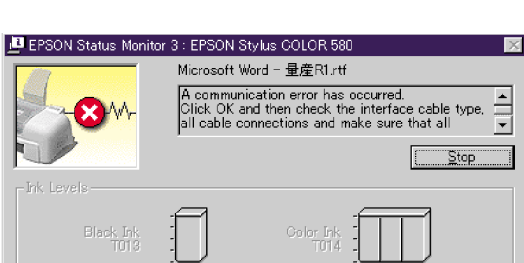
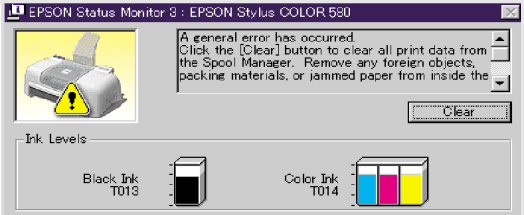
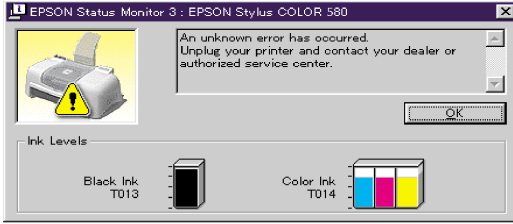
In your repair activity, connect the printer to your PC and check the Status monitor 3 by identify the trouble because this printer dose not have control panel. Based on the Status monitor 3 indication or phenomenon, check the printer more detail by referring the corresponding check table.

Table 3-8. Symptoms and possible cause

Symptom	Possible Cause	Check table
Paper out error indication on STM3 (Paper is not loaded correctly)	<ul style="list-style-type: none"> The friction of the LD roller is lowered due to the paper dust. The clutch mechanism is broken. Tension spring 0.143 come off in the clutch mechanism. Compression spring 0.98 comes off. Tip of Change lever has any damage. PF motor is broken 	Table 3-9 Table 3-10 Table 3-11
Paper jam error indication on STM3	<ul style="list-style-type: none"> Star wheel assembly is not assembled on the Paper eject frame. The Spur gear 15 is not assembled correctly The paper guide front is not assembled correctly or has any damage. The PE detection lever dose not move smoothly 	Table 3-12 Table 3-13 Table 3-14
Multiple papers are always loaded.	<ul style="list-style-type: none"> The paper return plate dose not work correctly. 	Table 3-15
Paper is always loaded without any print job	<ul style="list-style-type: none"> The Change lever is broken in the Clutch mechanism. 	Table 3-16

Table 3-8. Symptoms and possible cause (continued)

Symptom	Possible Cause	Check table
General error indication on the STM3	<ul style="list-style-type: none"> HP/IC sensor lever or PE sensor lever dose not move smoothly. HP/PE/IC sensor is defective. CR motor is defective. PF motor is defective Main board is defective. Printer Housing dose not secured with screw on -the printer mechanism 	Table 3-17 Table 3-18 Table 3-19
Communication error on the STM3	<ul style="list-style-type: none"> The main board is defective The power supply board is defective. The parallel cable dose not support the bi-directional transportation. The suitable print driver is not installed into the PC. 	Figure 3-20
Any error indication is not displayed. But, the paper is not ejected completely. Paper jam dose not occur.	<ul style="list-style-type: none"> Paper eject roller gear is disengaged from the pump’s gears. The Paper eject frame is not assembled in the Paper eject frame. 	Figure 3-21
Dot missing occur and it is not recovered with CL	<ul style="list-style-type: none"> Pump unit dose not absorb the ink from the printhead. Cap unit dose not stick on the surface of the printhead completely. The printhead is broken The head FFC has any damage. The main board is defective. 	Figure 3-22 Figure 3-23 Figure 3-24
Print quality is not good <ul style="list-style-type: none"> Vertical banding Horizontal banding Printing is blurred Ink stains the paper 	<ul style="list-style-type: none"> The accuracy of the CR motor is lowered. The lack of the lubricant around the CR unit. The both I/C is not held in the CR unit securely. The Paper eject frame is deformed. Any foreign material is sticking around the printhead. Paper feed accuracy is lowered. Printer driver setting is not suitable. Paper path has ink stain somewhere. 	Table 3-25 Table 3-26 Table 3-27

If the problem fits to the detail phenomenon in the table, make sure the check point and repair the product following the corresponding remedy mentioned in the table when you find the defective parts in the check point.

Table 3-9. Paper out error indication on STM3

Paper out error indication on STM3			
Step No.	Detail phenomenon	Check point	Remedy
1	ASF LD roller attempt to load the paper. But, paper is not loaded at all. The LD roller seems slipping.	<ul style="list-style-type: none"> Check the surface of the LD roller if the micro pearl or severe smear is adhered.  <p>LD roller</p> <p>If it is no problem, proceed the next step</p>	<ul style="list-style-type: none"> Set a cleaning sheet in the ASF up side down. Then holding the top edge, try to load the paper from the Printer driver. The micro pearl on the LD roller surface is removed. To remove severe smear, staple a cloth moistened with alcohol to a post card and clean the roller in the same manner.  <p>Non-adhesive Area CL Sheet Adhesive Area This side down</p> <p>(Use a post card for the base sheet.) Staplers Cloth moistened with alcohol</p> <ul style="list-style-type: none"> If the problem is not solved, replace the LD roller with new one.

Table 3-10. Paper out error indication on STM3

Paper out error indication on STM3			
Step No.	Detail phenomenon	Check point	Remedy
2	ASF LD roller dose not attempt to load the paper. But, the PF motor and the Spur gear 35.2 is rotating.	<ul style="list-style-type: none"> Check if the clutch tooth is broken.  <p>Clutch tooth</p>  <p>Spur gear 35.2</p> <p>If it is no problem, proceed the next step.</p>	<ul style="list-style-type: none"> Replace the clutch mechanism with new one.
3	ASF LD roller dose not attempt to load the paper. But, the PF motor and the Spur gear 35.2 is rotating.	<ol style="list-style-type: none"> Check if the tension spring 0.143 comes off in the Clutch mechanism.  <p>Tension spring 0.143</p>	<ol style="list-style-type: none"> Se the tension spring 0.143 in the clutch mechanism. Set the Compression spring 0.98 in the Change lever.

Table 3-11. Paper out error indication on STM3

Paper out error indication on STM3			
Step No.	Detail phenomenon	Check point	Remedy
4	When the print data is sent to the printer, ASF LD roller continue to load the paper even if the first paper is loaded to the PF roller and the paper is ejected while the ASF hopper is flapping.	<ol style="list-style-type: none"> 1. Check if the tip of the Change lever has any damage.  <p>Change lever</p> <p>comp. spring 0.98</p> <ol style="list-style-type: none"> 2. Check if the Compression spring 0.98 comes off from the Change lever <p>If it is no problem, proceed the next step.</p>	<ol style="list-style-type: none"> 1. Replace the Change lever with new one. 2. Set the Compression spring 0.98 in the Change lever.
5	When the printer is turned on, ASF hopper dose not operate at all in the power on sequence	<ol style="list-style-type: none"> 1. Check if the PF motor connector is connected to the CN3. 2. Check if the PF motor coil resistance is about 7ohm by using tester Refer to Table 3-1. 	<ol style="list-style-type: none"> 1. Connect the PF motor connector to the CN3 on the Main board. 2. Replace the PF motor with new one. 3. If the problem is not solved, replace the Main board with new one.

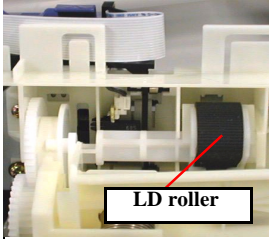
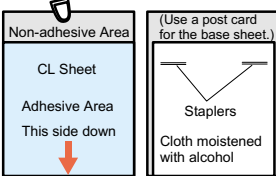
Table 3-12. Paper jam error indication on STM3

Paper Jam error indication on STM3			
Step No.	Detail phenomenon	Check point	Remedy
1	Paper is not ejected completely and jammed around the Paper eject frame.	<ul style="list-style-type: none"> • Check if the star wheel assembly is assembled in the Paper eject frame.  <p>Star wheel assy</p> <p>If it is no problem, proceed the next step</p>	<ul style="list-style-type: none"> • Remove the jammed paper and assemble the Star wheel assembly in the Paper eject frame completely. If the hook portion of the Star wheel assembly is broken, replace the Star wheel assembly with new one.
2	Ditto	<ul style="list-style-type: none"> • Check if the Paper eject roller is rotating correctly.  <p>Paper eject roller</p> <p>Spur gear 15</p> <p>If it is no problem, proceed the next step</p>	<ul style="list-style-type: none"> • Set the tip of the Spur gear 15 to the protrusion of the Pump unit and assemble it correctly.

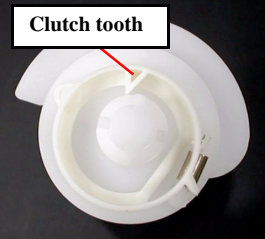
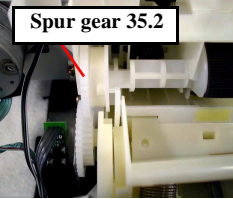
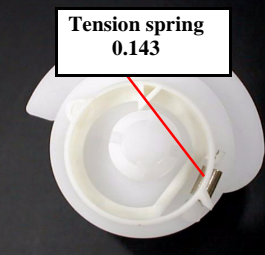
Table 3-13. Paper jam error indication on STM3

Paper Jam error indication on STM3			
Step No.	Detail phenomenon	Check point	Remedy
3	The paper is jammed around the Front paper guide.	<ol style="list-style-type: none"> 1. Check if the Front paper guide is floating from the assemble position. 2. Check if there is any damage around the rear edge of the each rib on the Front paper guide.  <p>If it is no problem, proceed the next step</p>	<ol style="list-style-type: none"> 1. Assemble the Front paper guide front to the suitable portion and confirm the PF grounding spring is securing the Front paper guide. 2. Replace the Front paper guide with new one. 
4	Paper is loaded correctly from ASF. But, after complete the print job, paper jam indicated on the screen without any paper jam. If you send the new print job in this condition, the General error is indicated on the screen.,	<ul style="list-style-type: none"> • Check if the Torsion spring 0.22 comes off on the both PE sensor lever.  <p>If it is no problem, proceed the next step</p>	<ul style="list-style-type: none"> • If the Torsion spring 0.22 is not set on the correct position, set it correctly. If any paper dust is placed around the PE sensor lever, remove it

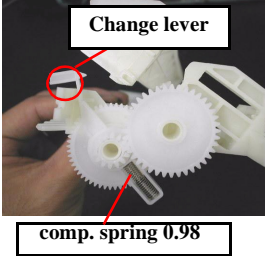
Table 3-14. Paper jam error indication on STM3

Paper Jam error indication on STM3			
Step No.	Detail phenomenon	Check point	Remedy
5	When the paper is loaded from the ASF and ejected without any printing. After eject the paper, paper eject sequence is continued. If any print job is sent to the printer, General error is displayed on the STM.	<ol style="list-style-type: none"> 1. Check if the CN1 connector cable for HP/PE/IC sensor cable is disconnected on the Main board or sensor. 2. Check if the HP/PE/IC sensor operates correctly by using the tester. Refer to Table 3-2. 	<ol style="list-style-type: none"> 1. Connect the CN1 connector cable to the CN1 on the Main board. 2. Replace the HP/PE/IC sensor with new one. 3. If the problem is not solved, replace the Main board with new one.

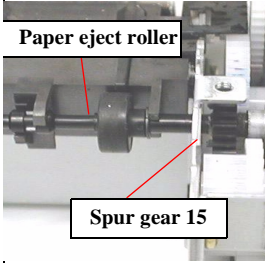
Table 3-15. Multiple papers are always loaded

Multiple papers are always loaded.			
Step No.	Detail phenomenon	Check point	Remedy
1	Any error indication is not displayed on the monitor. But, multiple papers are always loaded from ASF.	Check if the Paper return plate is operating correctly in the ASF when the paper is loaded.	<ul style="list-style-type: none"> Assemble the torsion spring 28.9 in the ASF frame.  <p>Torsion spring 28.9</p>

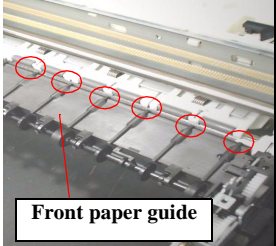
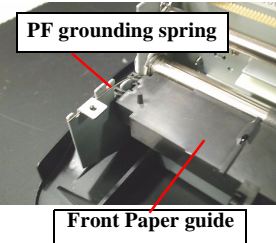
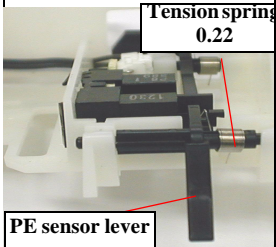
Table 3-16. Paper is always loaded without any print job

Paper is always loaded without any print job			
Step No.	Detail phenomenon	Check point	Remedy
1	Paper is always loaded from ASF without any print job. ASF hopper continue to flapping when the printer is turned on.	<ol style="list-style-type: none"> Check if the tip of the Change lever has any damage.  <p>Change lever</p> <p>comp. spring 0.98</p> <ol style="list-style-type: none"> Check if the Compression spring 0.98 comes off from the Change lever 	<ol style="list-style-type: none"> Replace the Change lever with new one. Set the Compression spring 0.98 in the Change lever.

Table 3-17. General Error indication on the STM3

General Error indication on the STM3			
Step No.	Detail phenomenon	Check point	Remedy
1	When the printer is turned on, the printer continue the paper eject sequence even if the paper is not in the paper path.	1. Check if the Torsion spring 0.22 comes off on the both HP/IC sensor lever.	1. Set the Torsion spring 0.22 on the HP/IC sensor lever.
		 <p>HP/IC sensor lever</p> <p>Torsion spring 0.22</p>	
		2. Check if the Torsion spring 0.22 comes off on the both PE sensor lever.	2. Set the Torsion spring 0.22 on the PE sensor lever.
		 <p>Tension spring 0.22</p> <p>PE sensor lever</p>	
		3. Check if the CN1 connector cable is connected on the CN1 on the Main board or sensor.	3. Connect the CN1 connector cable to the CN1 on the Main board.
		4. Check if the HP/PE sensor work correctly by using the tester. Refer to Table 3-2	4. Replace the HP/PE/IC sensor with new one.
			5. If the problem is not solved, replace the Main board with new one.

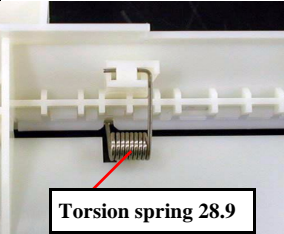
Table 3-18. General Error indication on the STM3

General Error indication on the STM3			
Step No.	Detail phenomenon	Check point	Remedy
2	When the printer is turned on, the CR unit dose not move at all in the power on sequence.	1. Check if the CR motor connector is connected CN2 on the Main board. 2. Check if the coil resistance of the CR motor is about 7.8ohm by using the tester. Refer to Table 3-1.	1. Connect the CR motor connector to the CN2 on the Main board. 2. Replace the CR motor with new one. 3. If the problem is not solved, replace the Main board with new one.
3	When the printer is turned on, PF roller dose not rotate at all in the power on sequence.	1. Check if the PF motor connector is connected to the CN3. 2. Check if the PF motor coil resistance is about 7ohm by using tester	1. Connect the PF motor connector to the CN3 on the Main board. 2. Replace the PF motor with new one. 3. If the problem is not solved, replace the Main board with new one.

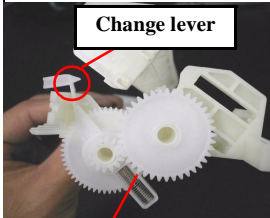
Table 3-19. General Error indication on the STM3

General Error indication on the STM3			
Step No.	Detail phenomenon	Check point	Remedy
4	When the printer is turned on, it sounds strange noise and the CR unit is stopped around the CR lock lever.	1. Check if the Top housing is secured with the fixing screw at the front side. 	1. Secure the Housing fixing screw at the printer front side.
		2. Check if the Change lever is placed to the printer front side. 	2. Turn back the Change lever to the printer back side with the tweezers or small screw driver.
		3. Check if the PF motor is operated. Check the CN3 connector and the coil resistance for PF motor.	3. Connect the PF motor cable to CN3 on the Main board. Replace the PF motor with new one.
		4. If the CR lock lever is not released even if the PF motor rotates in the power on sequence, check if one of the gears has any damage in the PF motor torque transportation path. Refer to Figure 2-14.	4. Change the damaged gear with new one. 5. If the problem is not solved, replace the Main board with new one.

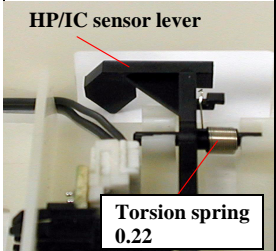
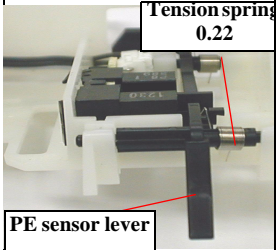
Table 3-20. Communication error on the STM3

Communication Error on the STM3			
Step No.	Detail phenomenon	Check point	Remedy
1	When the printer is turned on, printer does not operate at all.	1. Check if neither CR motor nor PF motor work at all when the printer is turned on.	1. Replace the PS board with new one. 2. If the problem is not solved, replace the main board with new one.
2	When the printer is turned on, power on sequence is operated correctly. But, when any print job is sent to printer, communication error is indicated on the monitor.	1. Check if SC580 printer driver is used for the print job. 2. Check if the incorrect model name is stored in the 02<H> address of the EEPROM in the Main board. 3. Check if scan monitor is installed in the PC and it is active.	1. Install the SC580 printer driver in the PC. 2. Write down 01<H> data into the 02<H> address of the EEPROM by using the Dump.exe program. 3. Close the scan monitor in the Windows task bar or overwrite the latest ESCPCSCAN.DLL. 4. If the problem is not solved, replace the main board with new one.

Table 3-21. Paper is not ejected completely without any error indication

Paper is not ejected completely without any error indication			
Step No.	Detail phenomenon	Check point	Remedy
1	Printing is normal. But, the paper is not ejected completely and the bottom area stay around the Paper eject frame.	<ol style="list-style-type: none"> 1. Check if the Paper eject roller rotate when the paper is ejected. 2. Check if the Paper eject frame is secured with the three fixing screws to the Main frame. 	<ol style="list-style-type: none"> 1. Assemble the Spur gear 15 to the protrusion on the pump unit. 2. Secure the Paper eject frame with the two fixing screws to the Main frame.

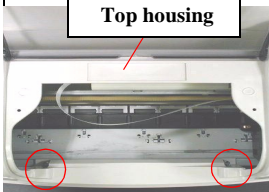
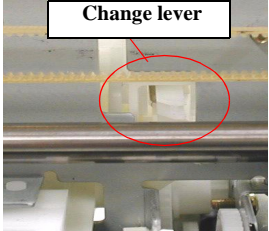
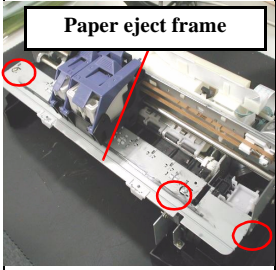
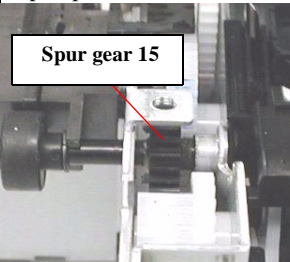

Table 3-22. Dot missing occur and it is not recovered with CL

Dot missing occur and it is not recovered with CL			
Step No.	Detail phenomenon	Check point	Remedy
1	In the CL sequence, the pump unit seems work correctly. But, ink is not ejected to the waste ink pad at all. Moreover, any ink is not absorbed from the head to the cap.	<ol style="list-style-type: none"> 1. Check if ink is ejected to the waste ink pad via pump unit in the CL sequence. 2. Check if there is any foreign material around the seal rubber parts on the cap assembly. 3. Check if any damage is observed around the seal rubber parts on the cap assembly. 4. Check if the two compression spring are assembled in the Cap assembly correctly. 	<ol style="list-style-type: none"> 1. If ink is not ejected at all to the waste ink pad in the CL sequence, proceed the following check point 2). 2. Remove the foreign material around the seal rubber parts. 3. Replace the Cap assembly with new one. 4. Set the Compression spring into the Cap assembly.

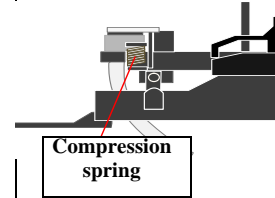
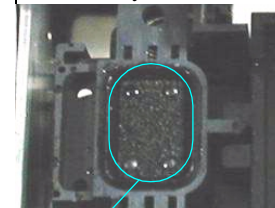

Table 3-23. Dot missing occur and it is not recovered with CL

Dot missing and it is not recovered with CL			
Step No.	Detail phenomenon	Check point	Remedy
1	In the CL sequence, the pump unit seems work correctly. But, any ink is not ejected to waste ink pad. Moreover, any ink is not absorbed from the head to the cap.	<p>5) Check if the Pump tube is connected to the bottom of the Cap assembly correctly</p>  <p>6) Check if the pump tube has a little slack between the Cap assembly and the pump unit when the Cap assembly is slide up completely.</p> 	<p>5) Connect the Pump tube to the bottom of the Cap assembly deeply.</p> <p>6) Pump unit may coil the pump tube inside the unit. In this case, pull out the coiled tube from the pump unit carefully. After that, connect the pump tube to the Cap assembly after placing the tube correctly.</p> <p>7) If the problem is not solved, replace the Pump unit with new one.</p>

Table 3-24. Dot missing occur and it is not recovered with CL

Dot missing occur and it is not recovered with CL			
Step No.	Detail phenomenon	Check point	Remedy
2	In the CL sequence, ink is ejected to the Waste ink pad (this means pump unit & cap unit are working correctly). But, the dot missing is not solved at the specific nozzles even if the several CLs are performed.	<ol style="list-style-type: none"> 1. Check if the segment in the nozzle check patten is reduced every CL & Nozzle check pattern printing. 2. Check if any damage is observed on the Head FFC. 	<ol style="list-style-type: none"> 1. Replace the I/C with new one in the I/C replacement sequence. 2. Replace the Head FFC with the new one. 3. Replace the printhead with new one.
3	In the CL sequence, ink is ejected to the Waste ink pad. But, dot missing is occurred on all nozzle in the printing and is not solved in the several CLs.	<ol style="list-style-type: none"> 1. Check if the Head FFC is connected to the CN4 on the Main board or Head FFC. 	<ol style="list-style-type: none"> 1. Connect the Head FFC securely to the CN4 on the Main board or Printhead. 2. Replace the Printhead with new one. 3. Replace the Main board with new one.

Table 3-25. Print quality is not good

Print quality is not good			
Step No.	Detail phenomenon	Check point	Remedy
1	<p>Vertical banding is appeared against the CR movement direction. And it looks like uneven printing.</p> 	<ol style="list-style-type: none"> 1. Check if each segment is printed correctly in the nozzle check pattern. 2. Check if the surface of the CR guide shaft dose not have any sever stain. 3. Check if the surface of the CR sliding portion on the Paper eject frame has enough oil. 4. Check if the CR guide shaft is assembled in the correct portion securely. 5. Check if the surface of the CR guide shaft is flat. 6. Check if the surface of the Paper eject frame is flat. 	<ol style="list-style-type: none"> 1. Perform the CL and check the nozzle check pattern. 2. Clean the surface of the CR guide shaft with the dry soft cloth and lubricate G-55 inside the CR guide shaft. Refer to Figure 6-4. 3. Clean the surface of the CR sliding portion on the Paper eject frame and lubricate specific amount of the G-26. Refer to Figure 6-8. 4. Reassemble the CR guide shaft into the mounting slat on the both side frame and secure it with Rod spring. Figure 4-50 and Figure 4-51. 5. Replace the CR guide shaft with new one. 6. Replace the Paper eject frame with new one.

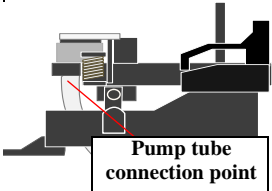
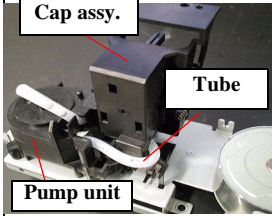
Table 3-26. Print quality is not good

Print quality is not good			
Step No.	Detail phenomenon	Check point	Remedy
1	Ditto	7) Check if the rubber parts are stuck inside the I/C cover.	<ol style="list-style-type: none"> 7. Stick the rubber parts inside the I/C cover. 8) Replace the following parts. <ul style="list-style-type: none"> • CR motor • CR timing belt • Compression spring 15.7
2	<p>Micro banding appears horizontally against the paper feeding direction and it appears with the same width.</p> 	<ol style="list-style-type: none"> 1. Check if each segment is printed correctly in the nozzle check pattern. 2. Check if the suitable paper is used according to the printer driver setting. 3. Check if the Paper feed roller is dirty. 4. Check if the following parts do not have any damage. <ul style="list-style-type: none"> • Combination gear 8.4, 21.6 • Combination gear 9.6,33.6 • Spur gear 35.4. • Spur gear 15 	<ol style="list-style-type: none"> 1. Perform the CL and check the nozzle check pattern. by using the Adjustment program. 2. Use the suitable paper according to the printer driver setting. 3. Clean the surface of the PR roller carefully with the soft brush 4. Replace the damaged parts with new one. 5. Replace the Printhead with new one.

Table 3-27. Print quality is not good

Print quality is not good			
Step No.	Detail phenomenon	Check point	Remedy
3	Printing is blurred.	<ol style="list-style-type: none"> 1. Check if the suitable paper is used according to the printer driver setting. 2. Check if the correct head ID is stored in the EEPROM by using the Adjustment program. 	<ol style="list-style-type: none"> 1. Use the suitable paper according to the driver setting. 2. Input 6 digits code of the head ID into the EEPROM by using the Adjustment program.
4	Ink stains the paper	<ol style="list-style-type: none"> 1. Check if the following parts are stained with ink. <ul style="list-style-type: none"> • Upper paper driven roller • PF roller • Paper guide front • Paper eject roller. 2. Check if there is some ink drops around the backside of the printhead. 3. If the bottom area of the printed paper has ink stain, check if the Paper eject frame is secured with three screws. 4. If the bottom area of the printed paper has ink stain, check if the Paper eject frame is bent upward. 	<ol style="list-style-type: none"> 1. Clean the ink stained parts with soft cloth 2. Wipe off the ink drop with the soft cloth carefully. 3. Secure the screws fixing the Paper eject frame. 4. Replace the Paper eject frame with new one.

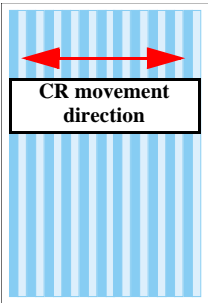
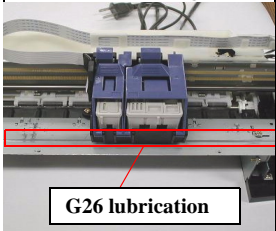
CHAPTER

4

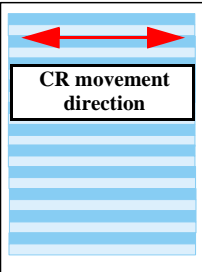
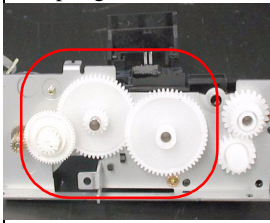
DISASSEMBLY AND ASSEMBLY

4.1 Overview

This section describes procedures for disassembling the main components of the Stylus COLOR 580. Unless otherwise specified, disassembly units or components can be reassembled by reversing the disassembly procedure. Things, if not strictly observed, that could result in injury or loss of life are described under the heading “Warning”. Precautions for any disassembly or assembly procedures are described under the heading “CAUTION”. Chips for disassembling procedures are described under the heading “CHECK POINT”.

If the assembling procedure is different from the reversed procedure of the disassembling, the procedure is described under the heading “REASSEMBLY”. Any adjustments required after disassembling the units are described under the heading “ADJUSTMENT REQUIRED”. When you have to remove any units or parts that are not described in this chapter, refer to the exploded diagrams in the appendix.

Read precautions described in the next section before starting.

4.1.1 Precautions

See the precautions given under the handling “WARNING” and “CAUTION” in the following column when disassembling or assembling EPSON Stylus COLOR 580.



- **Disconnect the power cable before disassembling or assembling the printer.**
- **Wear protective goggles to protect your eyes from ink. If ink gets in your eye, flush the eye with fresh water and see a doctor immediately.**
- **If ink comes into contact with your skin, wash it off with soap and water. If irritation occurs, contact a physician.**
- **A lithium battery is installed on the main board of this printer. Be sure to observe the following instructions when serving the battery:**
 1. **Keep the battery away from any metal or other batteries so that electrodes of the opposite polarity do not come in contact with each other.**
 2. **Do not heat the battery or put it near fire.**
 3. **Do not solder on any part of the battery. (Doing so may result in leakage of electrolyte from the battery, burning or explosion. The leakage may affect other devices close to the battery.)**
 4. **Do not charge the battery. (An explosion may be generated inside the battery, and cause burning or explosion.)**
 5. **Do not dismantle the battery. (The gas inside the battery may hurt your throat. Leakage, burning or explosion may also be resulted.)**
 6. **Do not install the battery in the wrong direction. (This may cause burning or explosion.)**
- **Danger of explosion if the battery is incorrectly replaced. Replace only with the same or equivalent type recommended by the manufacture. Dispose the used batteries according to government’s law and regulations.**

CAUTION

Risque d'explosion si la pile est remplacée incorrectement. Ne remplacer que par une pile du même type ou d'un type équivalent recommandé par le fabricant. Eliminer les piles déchargées selon les lois et les règles de sécurité en vigueur.

CAUTION

- Never remove the ink cartridge from the carriage unless this manual specifies to do so.
- When transporting the printer after installing the ink cartridge, be sure to pack the printer for transportation without removing the ink cartridge.
- Use only recommended tools for disassembling, assembling or adjusting the printer.
- Apply lubricants and adhesives as specified. (See Chapter 6 for details.)
- Make the specified adjustments when you disassemble the printer. (See Chapter 5 for details.)
- When assembling, if an ink cartridge is removed and needs to be installed again, be sure to install a new ink cartridge because of the following reasons;
 1. Once the ink cartridge mounted on the printer is removed, air comes in and creates bubbles in the cartridge. These bubbles clog ink path and cause printing malfunction.
 2. If an ink cartridge in use is removed and is reinstalled, ink quantity will not be detected correctly since the counter to check ink consumption is cleared.
- Because of the reasons above, make sure to return the printer to the user with a new ink cartridge installed.

4.1.2 Tools

Use only specified tools to avoid damaging the printer.

Name	Supplier	Parts No.
Phillips Screw Driver (No.1)	EPSON	B743800100
Phillips Screw Driver (No.2)	EPSON	B743800200
Nipper	EPSON	B740500100
Tweezers	EPSON	B741000100

4.1.3 Work Completion Check

If any service is made to the printer, use the checklist shown below to confirm all works are completed properly and the printer is ready to be returned to the user.

Table 4-1. Work Completion Check

Classification	Item	Check Point	Status	
Main Unit	Self-test	Is the operation normal?	<input type="checkbox"/> Checked <input type="checkbox"/> Not necessary	
	On-line Test	Is the printing successful?	<input type="checkbox"/> Checked <input type="checkbox"/> Not necessary	
	Printhead	Is ink discharged normally from all the nozzles?	<input type="checkbox"/> Checked <input type="checkbox"/> Not necessary	
	Carriage Mechanism		Does it move smoothly?	<input type="checkbox"/> Checked <input type="checkbox"/> Not necessary
			Is there any abnormal noise during its operation?	<input type="checkbox"/> Checked <input type="checkbox"/> Not necessary
			Is there any dirt or foreign objects on the CR Guide Shaft?	<input type="checkbox"/> Checked <input type="checkbox"/> Not necessary
			Is the CR Motor at the correct temperature? (Not too heated?)	<input type="checkbox"/> Checked <input type="checkbox"/> Not necessary
	Paper Feeding Mechanism		Is paper advanced smoothly? • No paper jamming? • No paper skew? • No multiple feeding? • No abnormal noise?	<input type="checkbox"/> Checked <input type="checkbox"/> Not necessary
			Is the PF Motor at correct temperature?	<input type="checkbox"/> Checked <input type="checkbox"/> Not necessary
			Is the paper path free of any obstructions?	<input type="checkbox"/> Checked <input type="checkbox"/> Not necessary
	Adjustment	Specified Adjustment	Are all the adjustment done correctly?	<input type="checkbox"/> Checked <input type="checkbox"/> Not necessary

Table 4-1. Work Completion Check (continued)

Classification	Item	Check Point	Status
Lubrication	Specified Lubrication	Are all the lubrication made at the specified points?	<input type="checkbox"/> Checked <input type="checkbox"/> Not necessary
		Is the amount of lubrication correct?	<input type="checkbox"/> Checked <input type="checkbox"/> Not necessary
Function	ROM Version	Version:	<input type="checkbox"/> Checked <input type="checkbox"/> Not necessary
Packing	Ink Cartridge	Are the ink cartridges installed correctly?	<input type="checkbox"/> Checked <input type="checkbox"/> Not necessary
	Protective Materials	Have all relevant protective materials been attached to the printer?	<input type="checkbox"/> Checked <input type="checkbox"/> Not necessary
Others	Attachments, Accessories	Have all the relevant items been included in the package?	<input type="checkbox"/> Checked <input type="checkbox"/> Not necessary

4.2 Disassembly

The flowchart below shows step-by-step disassembly procedures. When disassembling each unit, refer to the page number shown in the figure.

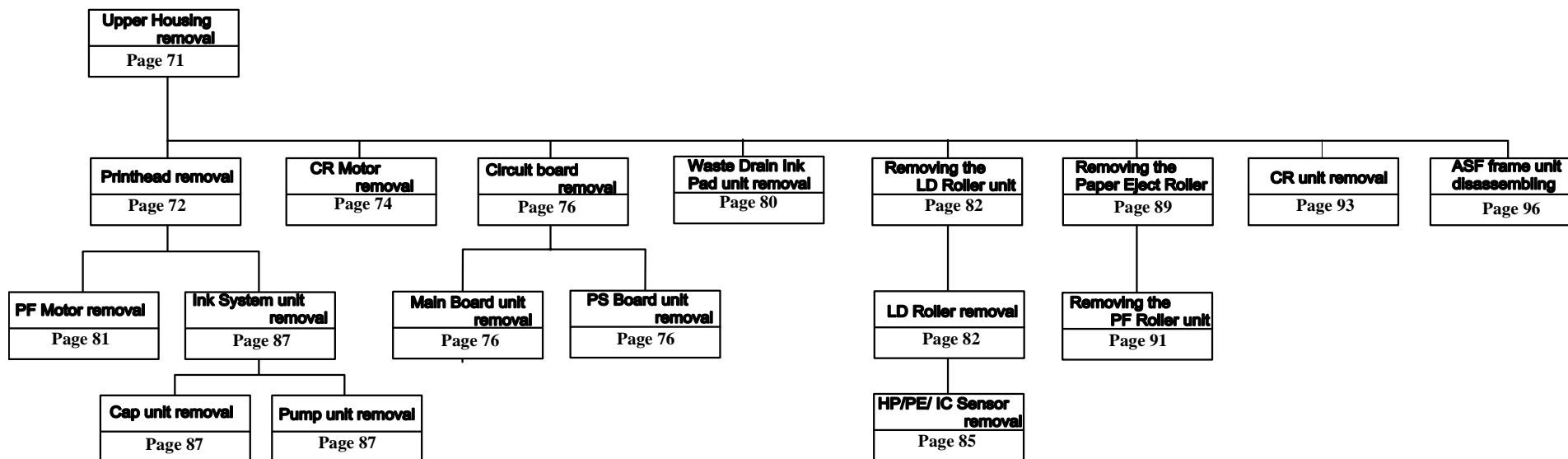

Figure 4-1. Disassembling Flowchart

4.2.1 Housing removal

1. Open the printer cover and remove 1 screw (C.B.P-TITE R 3x6 R/Uc screw) at the printer front side.

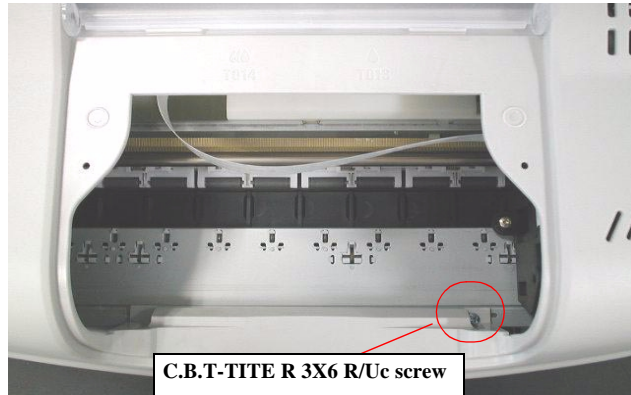

Figure 4-2. Removing 1screw for Housing

2. Remove 1 screw (C.B.S. 3x6 F/Zn screw) at the back of the printer and remove the Housing.



Figure 4-3. Removing 1screw for Housing



■ Tightening Torque for screw

- C.B.P-TITE R3x6 R/Uc screw for housing front side: 6 +/- 1kgf.cm
- C.B.S 3x6 F/Zn screw for housing back side : 6 +/- 1kgf.cm

4.2.2 Printhead removal

1. Remove the Housing from the printer. (Section 4.2.1 Housing removal)
2. Open the Cover cartridge and remove the both black and color ink cartridges.
3. Release the Printhead FFC from the cable holder in the left side of the CR unit.
4. Remove one screw (C.B.P.-TITE 3 x 6 F/Zn) tightening the Printhead at the left side of the CR unit.

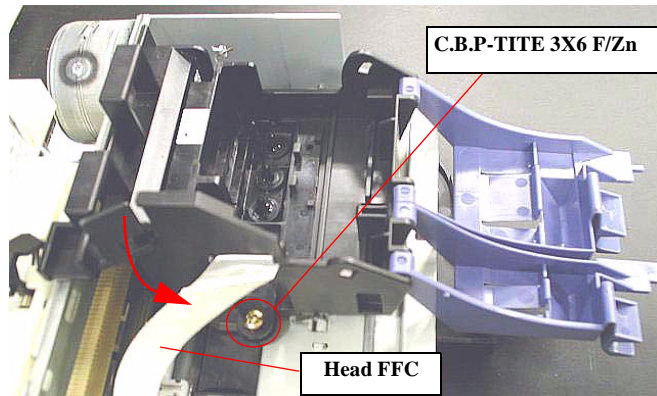

Figure 4-4. Removing the Printhead's FFC

5. Remove the Printhead from the CR unit taking the following step.

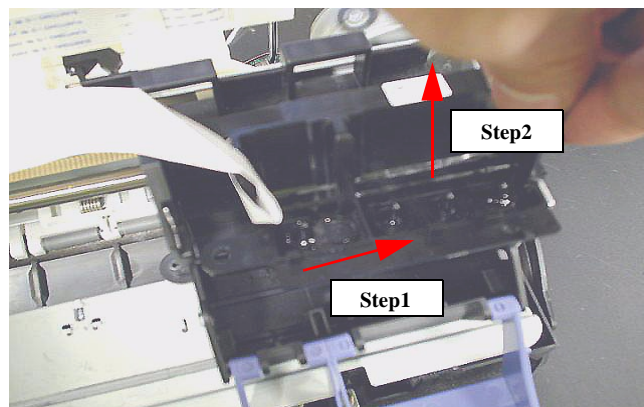

Figure 4-5. Removing the one screw tightening the Printhead

6. Disconnect the Printhead's FFC from the connector on the Printhead.]



- Place the Printhead's FFC in the cable holder by the four portions indicated in the following Figure4-6.
- Make sure that the Head Grounding Plate is installed to the carriage correctly. Refer to Figure 4-7.
- Make sure that two holes of the Printhead correctly fit in the installing position pins. Figure 4-7.

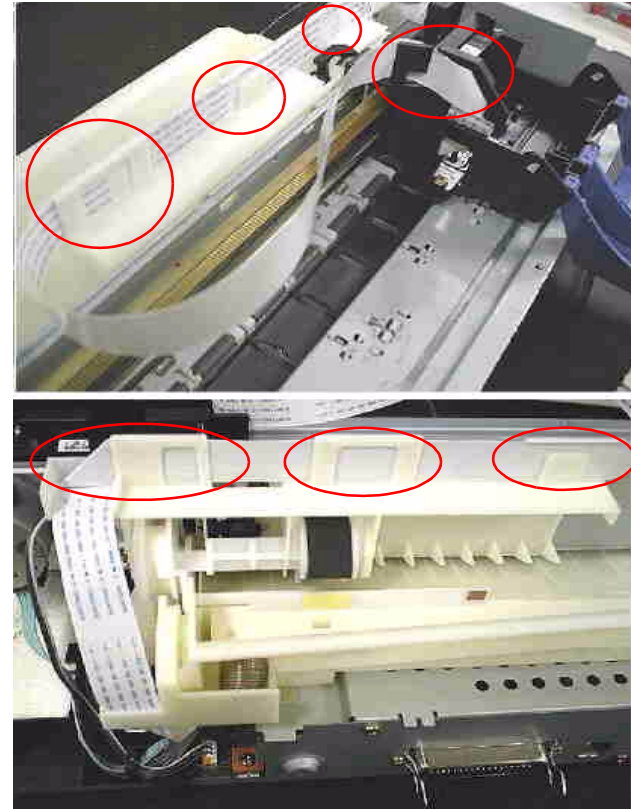

Figure 4-6. Placing the Printhead's FFC

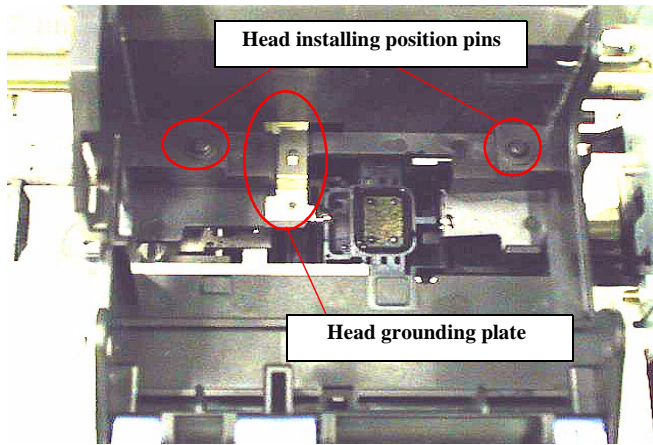

Figure 4-7.

Printhead installing the position pin & the grounding plate.



- Tightening Torque for screw
- C.B.P-TITE 3x8 screw for printhead: 6+/1kgf.cm



When the Printhead is replaced with a new one, following adjustments must be performed in the order below: Refer to Page109.

1. Initial ink charge
2. Printhead ID input
3. Bi-d adjustment

When the Printhead is removed and reinstalled, only the following adjustment is required. Refer to Page106.

1. Head cleaning
2. Bi-d adjustment

4.2.3 CR motor removal

1. Remove the Housing from the printer. (Section 4.2.1 Housing removal)
2. Move the CR unit from the CR home position to around the center position.
3. Push the CR motor from the right to left to slack the CR timing belt.
4. Take off the CR timing belt from the Pinion gear of the CR motor.

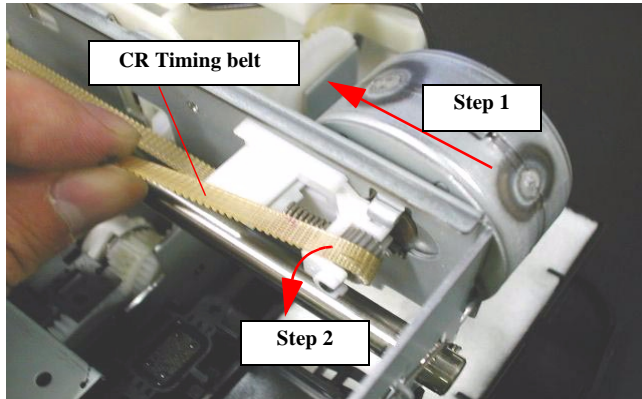

Figure 4-8. Taking off the CR timing belt.

5. Remove the Compression spring 15.7 and Holder reinforcement plate between the CR motor holder and the protrusion on the Main frame with the tweezers.

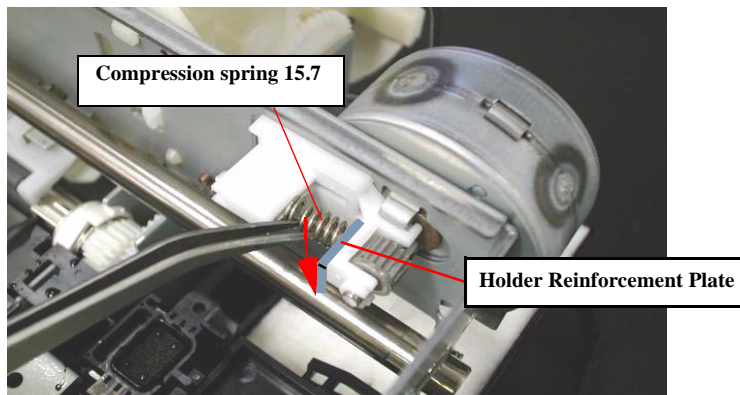

Figure 4-9. Remove the Compression spring 15.7

6. Slide the CR motor holder along with the CR motor to the left side
7. Remove the CR motor from the Printer mechanism taking the following step:
 - Slide the CR motor to right side. (Step2)
 - Slide the CR motor to backward to take off the fixing part placing the right side of the CR motor. (Step3)
 - Slide the CR motor to the left side to take off the fixing part placing the left side of the fixing part. (Step 4).

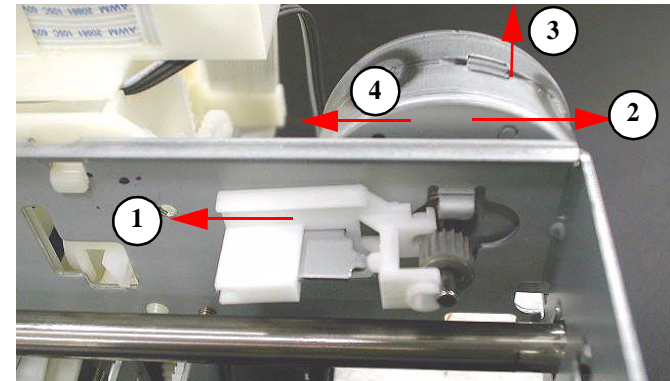

Figure 4-10. Removing the CR motor

8. Take the CR motor's cable out from the cable hook in the Waste drain ink pad unit.
9. Disconnect the CR motor connector cable from the CN2 on the Main board with tweezers.



■ The Gap adjustment (Bi-d adjustment) is required when the CR motor is removed or replaced. Refer to Page116.



- Connect the CR motor connector cable to the CN2 on the Main board. Use of tweezers or pincers is recommended to facilitate the job, since the CN2 is not located near the rear edge of the Main board.
- Make sure to set the Holder reinforcement plate with the Compression spring 15.7. Refer to Figure4-9.

4.2.4 Circuit board removal

1. Remove the Housing from the printer. (Section 4.2.1 Housing removal)
2. Remove two screws (C.B.S. 3x6, F/Zn) securing the Front Housing (Stacker guide) and remove the Front Housing (Stacker Guide).

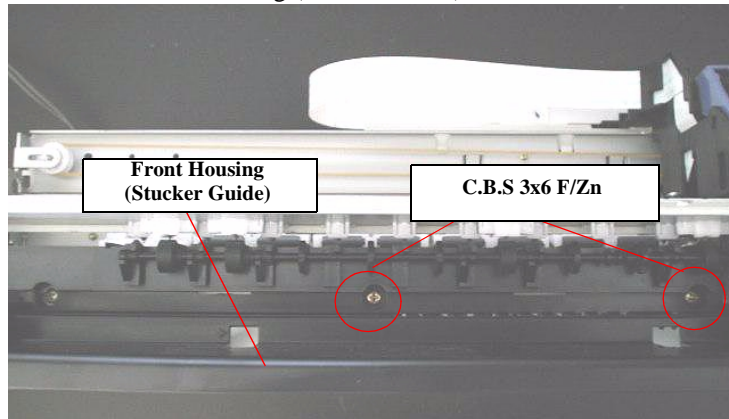

Figure 4-11. Removing the Front Housing (Stacker Guide)

3. Remove two screws (C.B.S. 3x6, F/Zn) securing the Circuit board unit at the front side of the Printer mechanism.

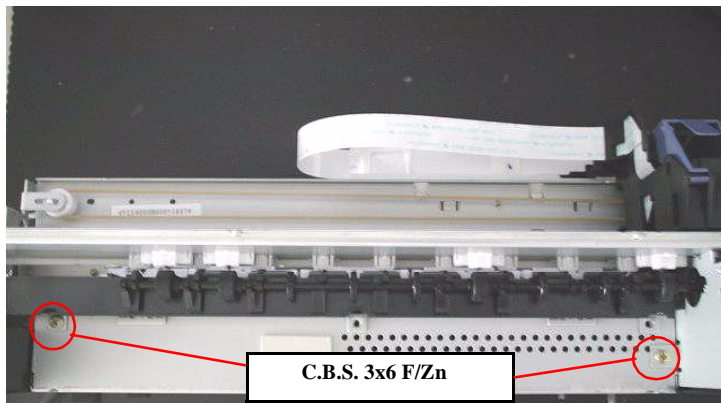

Figure 4-12. Removing two screws at the printer front side

4. Remove four screws (C.B.S.3x6, F/Zn) securing the Circuit board unit at the back side of the Printer mechanism and remove two screws (C.B.S. 3x6, F/Zn) securing the Circuit board unit at the right side (viewed from back side).

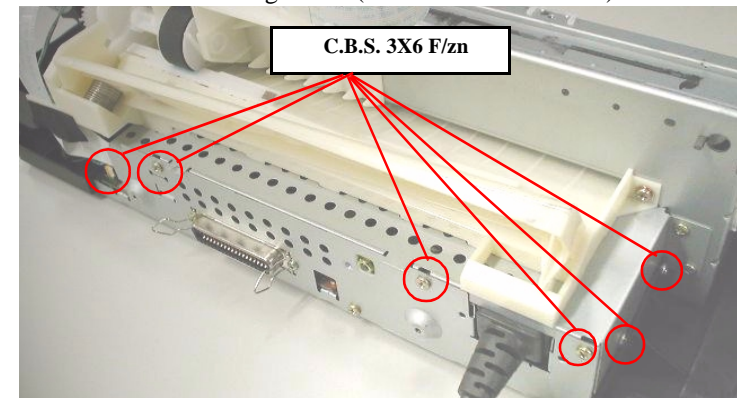

Figure 4-13. Removing six screws at the printer back side & right side

5. Holding the Left housing lightly, pull down the Circuit board unit. Then disconnect the following four cables from the corresponding connectors on the Main board.

- CR motor connector cable : CN2
- PF motor connector cable : CN3
- Printhead FFC : CN4
- HP/PE/IC sensor cable : CN1

6. Remove the following screws securing each circuit board to the Shield plate. Figure Figure 4-14.

- C364 MAIN/B : Remove five screws.
 C.B.S. 3x6, F/Zn (Red circled screws) : 3pcs (for Main board)
 C.P. 3x6, F/Zn (Yellow circled screws) : 2pcs (for Parallel I/F connector)
- C364PSB/E : Remove five screws.
 C.B.S, 3x6, F/Zn (Yellow circled screws) : 3pcs (for PS board)
 C.B.S-TITE R, 3x6, F/UC (Red circled screw) : 1pcs (for PS board)
 C.B.(O),4x5, F/ZG for 120V (Green circled screw):1pcs (for Earth terminal)

Hexagon nut, Normal M4(Green circled) :1pcs (for Earth terminal)
 (C.B.S Screw 3x6, F/Zn for 220V (Green circled screw): 1pcs (for Earth terminal))

NOTE: 110V type of the PS board dose not have earth wire.

Refer to the Figure 4-14

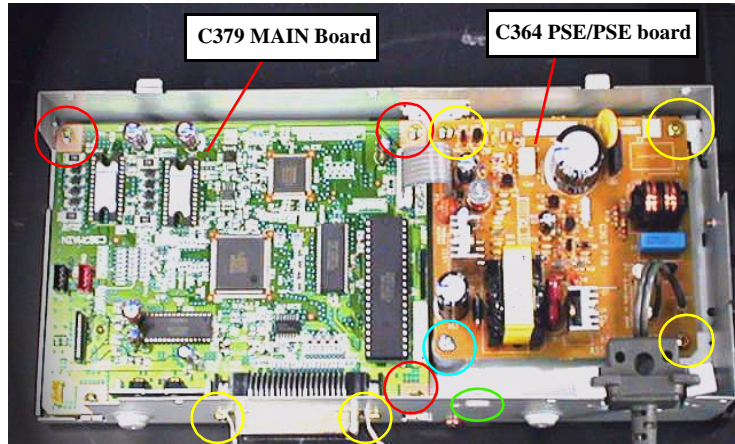

Figure 4-14. Remove the screw securing each circuit board.



On IC3 socket of the C379 MAIN-B Board, C379 SUB board may be equipped. This board is to use the 2sets of the 2M bit P-ROM instead of the 1chip of the 4M bit P-ROM.
 For the ASP P-ROM, only 4M bit OTP ROM is available for ASP and this C379 SUB board is not required to use 4M bit ROM.



When replacing the Main board with a new one, perform the following service items.

- Before removing the Main board, connect the USB I/F Cable and try to read out the following data by using the Adjustment program. If this operation succeeds, replace the Main board and write the read out data to the new Main board through the Adjustment program. Refer to Page112.

- 1) I/C Ink consumption counter.
- 2) Waste ink drain pad counter.
- 3) Printhead ID input.
- 4) Gap adjustment (Bi-d adjustment)

In case the above mentioned data are not able to be read out from the defective Main board, perform the following service items.

- Replace the both ink cartridges with a brand new one.
- Replace the Waste ink drain pad with a new one.
- Input the Printhead ID.
- Adjust the Bi-d alignment.



- Since the cable between C379 MAIN board and C364 PSB/E board are directly soldered, take the following steps when replacing only one circuit board in the service activity.

1. Take off the cable on the Main board by removing the solder by heating it with the soldering iron.
2. Replace the defective circuit board with new one.
3. Insert the tip of the cable into the soldering hole of the ASP Main board and solder it securely.

- Tightening Torque for screw

- C.B.S. 3x6 F/Zn screw for PS board : 6+/- 1kgf.cm
- C.B.S TITE R 3x6,F/Uc screw for PS board : 6+/- 1kgf.cm
- C.B.S. 3x6 F/Zn screw for Main board : 6+/- 1kgf.cm
- C.P. 3x6,F.Zn screw for Parallel I/F connector : 6+/- 1kgf.cm
- C.B.S. 3x6 F/Zn screw for Circuit unit : 6+/- 1kgf.cm
- C.B.(O) 4x5, F/ZG screw for Earth cable : 11+/-1kgf.cm

- The PF motor cable will be soldered on the C379 Main C. So, Before you replace the Main board with new one, take off the PF motor cable on the Main board by removing the solder by heating it with the soldering iron.

**CHECK
POINT**

When replacing or removing the PS board, be sure to use the following suitable screw to secure the PS board.

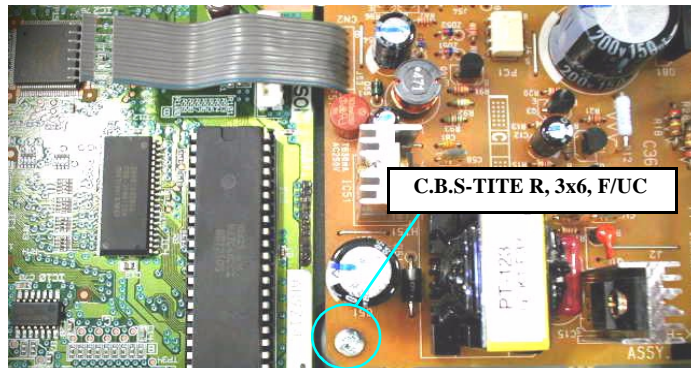

Figure 4-15. PS board fixing screws.

- Install a new cartridge before sending back the printer to the user, since the ink cartridge once taken out can not be used again.
- Installation of I/C must be carried out by I/C replacement sequence. Otherwise, ink may not eject properly. Refer to the Page101.



- Check the Earth terminal and wire position. Refer to the following figure. The earth wire for 120V must be placed back side of the Heat sinker HT1. And the earth wire for 220V must be placed in front of the Heat sinker HT1 as following figure.

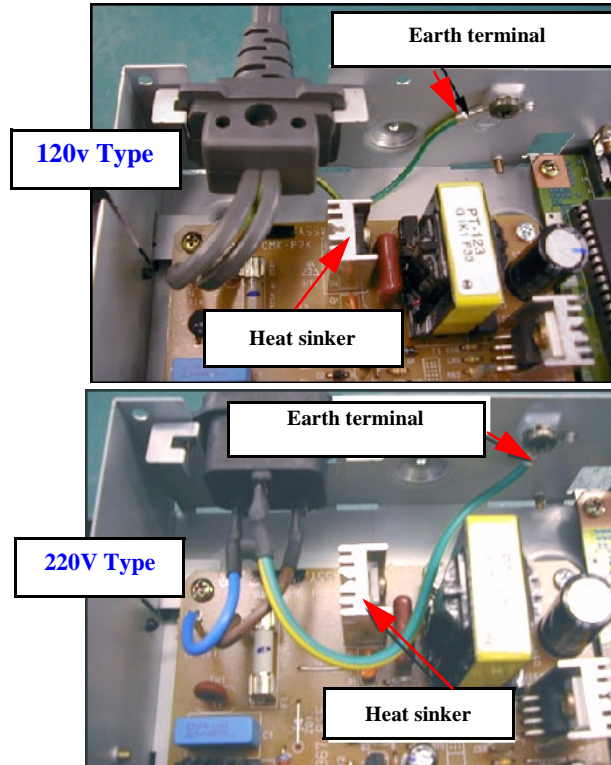

Figure 4-16. Earth terminal and wire position

4.2.5 Waste drain ink pad unit removal

1. Remove the Housing from the printer. (Section 4.2.1 Housing removal)
2. Remove one screw (C.B.P TITE 3x8 F/Zn screw) on the front right side of the printer. (viewed from front side)

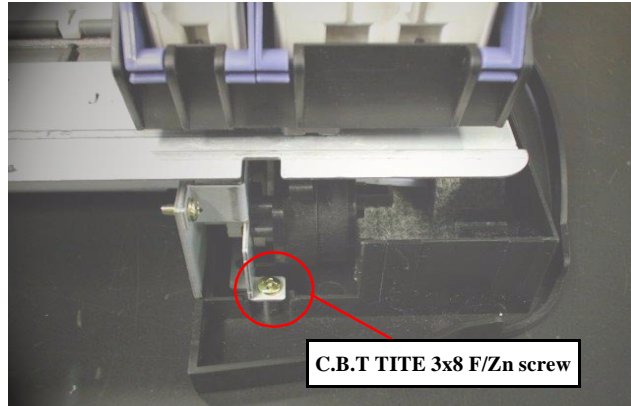

Figure 4-17. Removing one screw securing the Waste ink pad unit

3. Remove one screw (C.B.P. TITE 3x8 F/Zn screw) and take three cables off from the cable hook in the Waste drain ink pad unit as shown in the following figure.

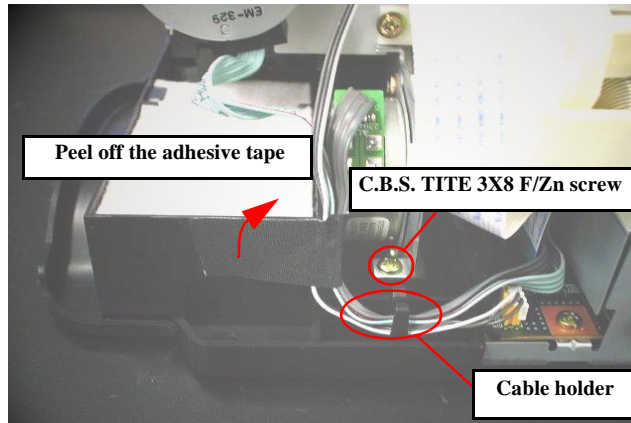

Figure 4-18. Removing one screws & cables at the back side of the printer

4. Remove the Waste drain ink pad unit from the printer



- After assembling the Waste drain ink pad unit, be sure to set the following three cables in the cable hook in the Waste drain ink pad unit. Refer to the Figure 4-18.
- When assembling the Waste drain ink pad unit, be sure to set the tip of the waste ink tube in the suitable position of the Waste drain ink pad. Refer to the Figure 4-19

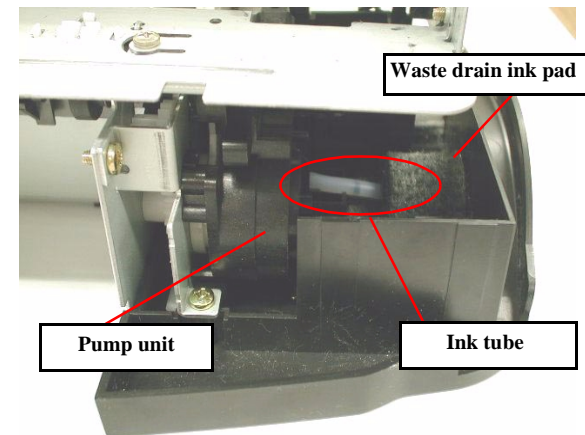

Figure 4-19. Drain ink tube setting position



When the Waste drain ink pad is replaced with a new one, following service item is required.

- Waste drain ink counter reset operation. Refer to Page117.



- Tightening torque for screw
 - C.B.P. TITE 3x8 screw for Waste drain ink pad unit: 9+1 kgf.cm

4.2.6 PF motor removal

1. Remove the Housing from the printer. (Section 4.2.1 Housing removal)
2. Remove the Waste drain ink pad unit from the printer. (Section 4.2.5 Waste drain ink pad unit removal)
3. Remove two screws (C.B.S. 3x6,F/Zn screw) securing the PF motor to the Ink system frame.

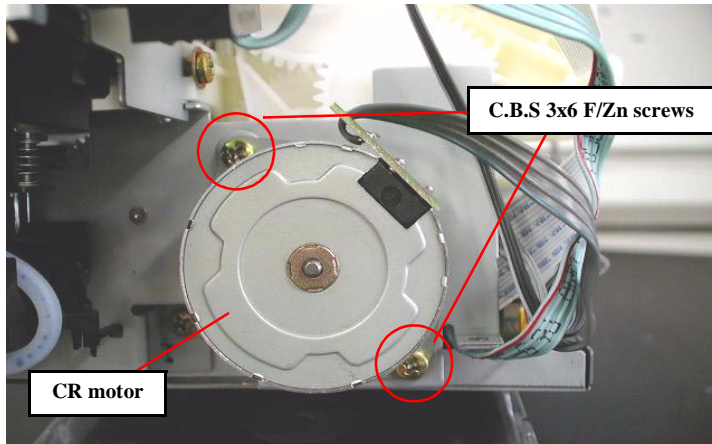

Figure 4-20. Removing two screws securing the PF motor

4. Disconnect the connector cable for PF motor from CN3 on the Main board and take the cable off from the hook on the Waste drain ink pad.
(On the C379Main- C board, the PF motor cable will be soldered on the Main board directly. So, in this case, take off the PF motor cable on the Main board by removing the solder by hearing it with the soldering iron.)
5. Remove the PF motor from the right frame.



- Since the CN 3 is not located near the rear edge of the Main board, it is easier to use the tweezers or pincers to connect the cable to the CN3.
- Tightening torque for screw
 - C.B.S. 3x6 F/Zn screw for PF motor : 9+/1 kgf.cm
 - If the Main board dose not have CN3 for the PF motor connector such as C378 Main-C, solder the ASP CN3 on the Main board and connect the PF motor cable connector to the CN3.

CHECK POINT



Be sure that the PF motor cable is placed to the backward. Refer to the Figure 4-20.

4.2.7 LD Roller removal

1. Remove the Housing from the printer. (Section 4.2.1 Housing removal)
2. Take the Head FFC off from the Head FFC holder located along the LD roller shaft holder.

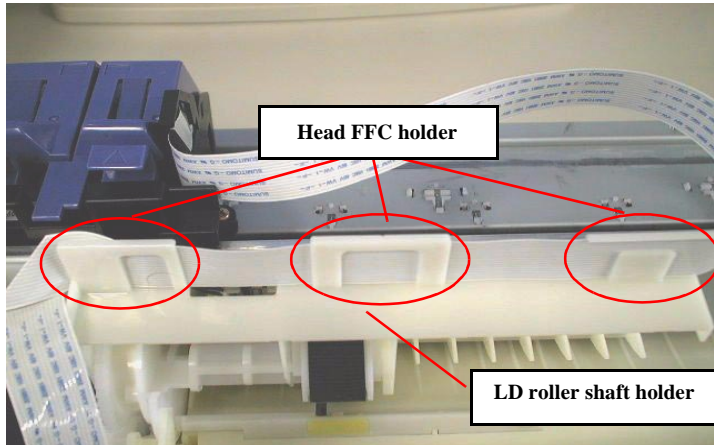

Figure 4-21. Taking Head FFC out from the FFC holder

3. Remove two screws (C.B.S. 3x6, F/Zn screw) securing the LD roller holder to the Main frame.

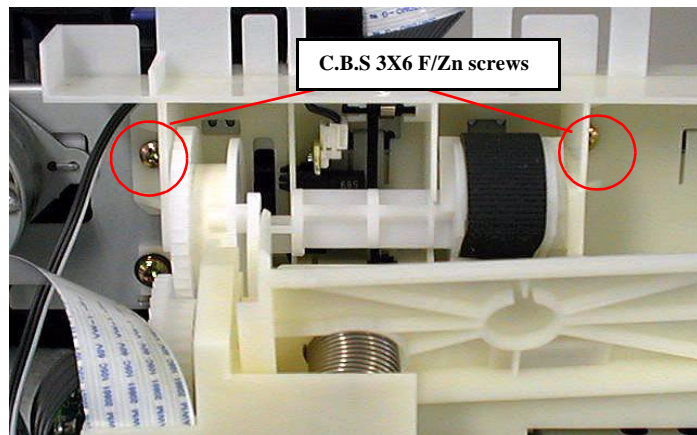

Figure 4-22. Removing two screws securing the LD roller holder

4. Push the two hooks of the LD roller shaft holder as shown in the following figure.
5. Pull the LD roller shaft holder unit upward from the Main frame.

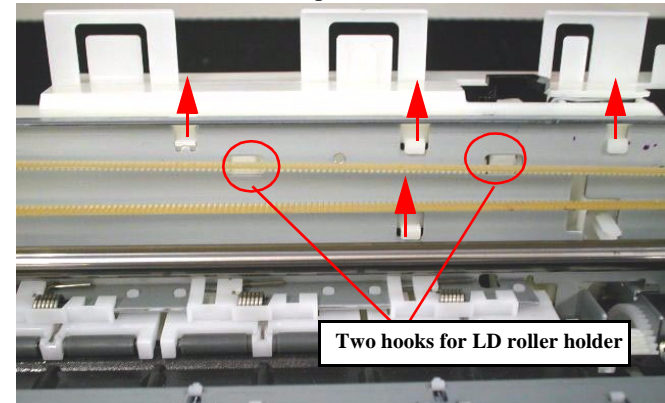

Figure 4-23. Pushing two hooks of the LD roller shaft holder

6. Remove the LD roller along with the Clutch mechanism from the LD roller shaft holder unit.

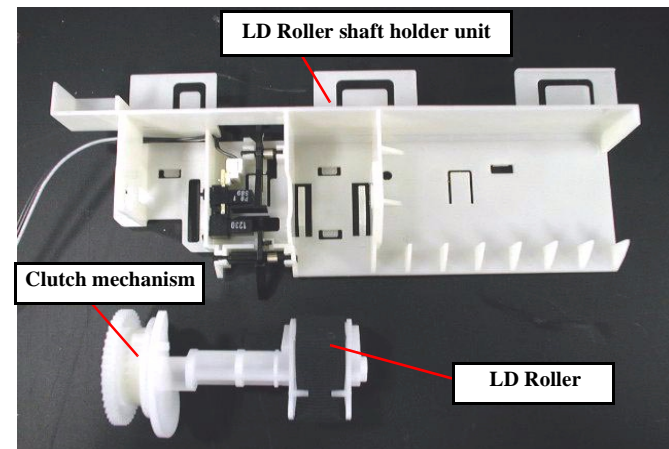

Figure 4-24. Removing the LD roller with Clutch mechanism.



- Do not damage the tooth of the Spur gear 35.2 and the Combination gear 11.2, 35.2 when assembling the LD roller shaft holder unit.

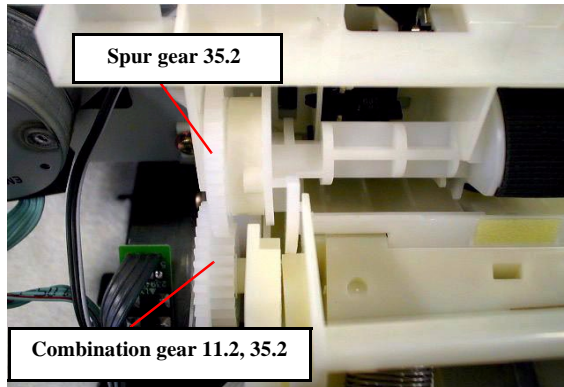

Figure 4-25.

Combination Gear 11.2, 35.2 and Spur Gear 35.2



- Before assembling the LD roller shaft, make sure that the round hole of the Clutch is set on the protrusion on the LD roller shaft as shown in the following figure.

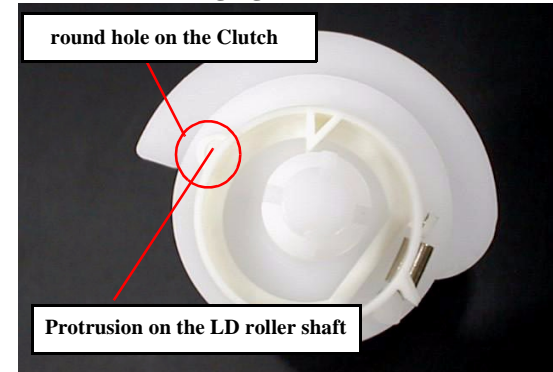

Figure 4-26. Assembling the Clutch

- Assemble the LD roller shaft holder unit to the printer mechanism in the following procedure.
 - Set the tip of the Change lever to the printer front side.

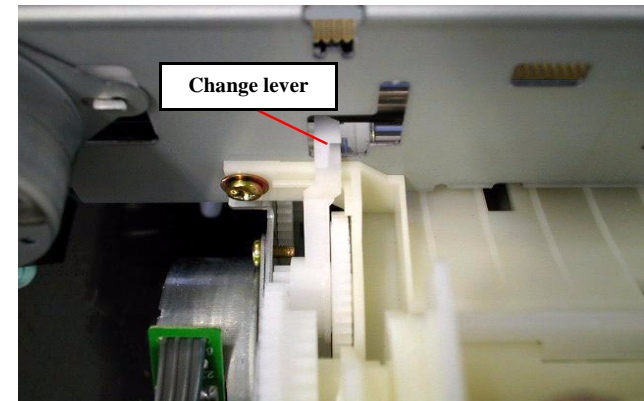

Figure 4-27. LD Roller shaft holder assembling procedure (1)



- 2) Assemble the LD roller shaft holder unit while storing the Paper return plate into the ASF frame.

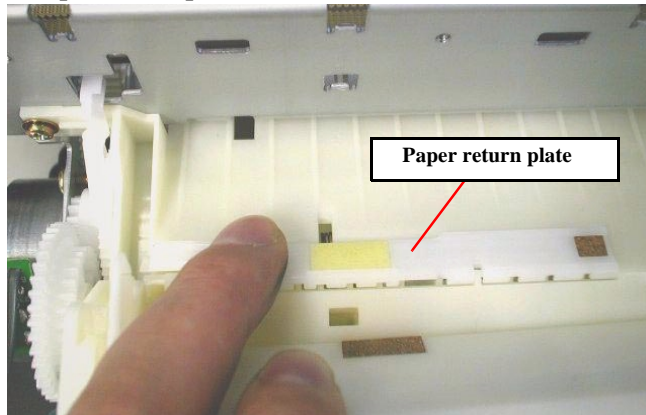

Figure 4-28. LD Roller shaft holder assembling procedure (2)

- Fasten the LD roller shaft holder with two C.B.S 3x6 F/Zn screws in the order indicated in the following figure.

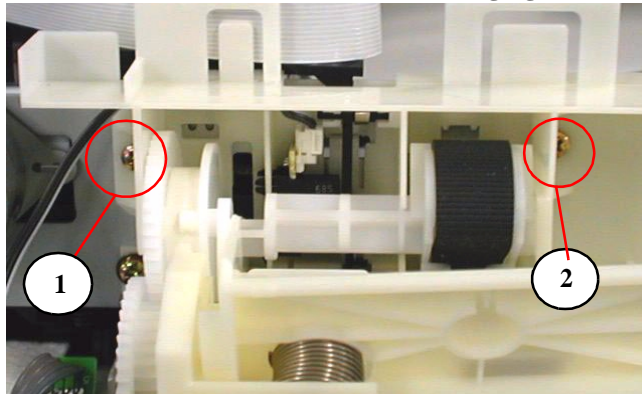

Figure 4-29. Fastening the LD roller shaft holder

- Tightening torque for screw
- C.B.S. 3x6 F/Zn screw for LD roller shaft holder unit: 9+/-1 kgf.cm

4.2.8 HP/PE/IC Sensor removal

1. Remove the Housing from the printer. (Section 4.2.1 Housing removal)
2. Remove the LD roller from the LD roller shaft holder. (Section 4.2.7 LD Roller removal)
3. Remove HP/IC detection lever from the LD roller shaft holder and disconnect the cable from the sensor connector.

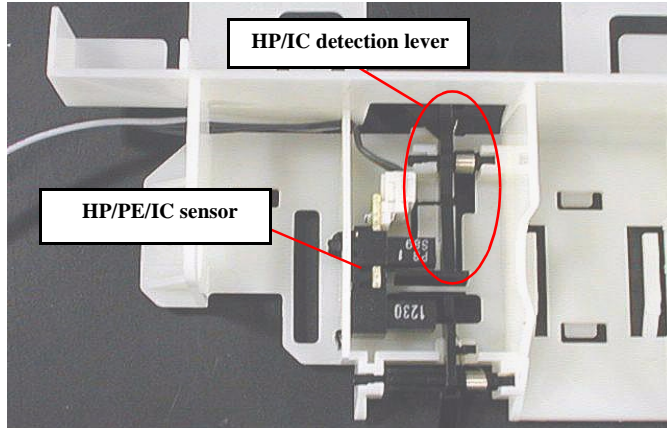

Figure 4-30. Removing the HP/IC detection lever

4. Release the two fixing hooks for the sensor from the LD roller shaft holder and remove the sensor.

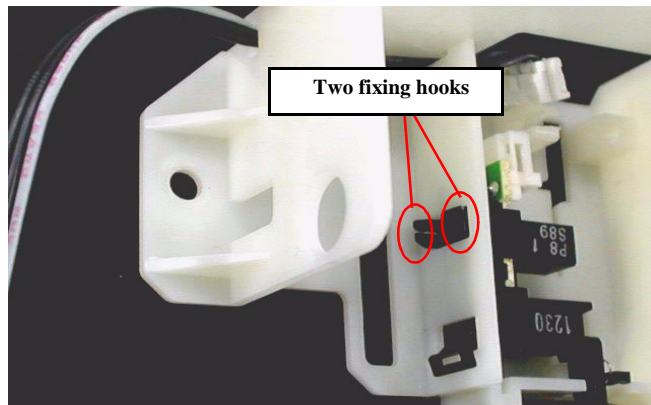

Figure 4-31. Releasing two fixing hooks for the sensor



- Make sure that the Torsion spring 0.22 is hung to the following suitable position.

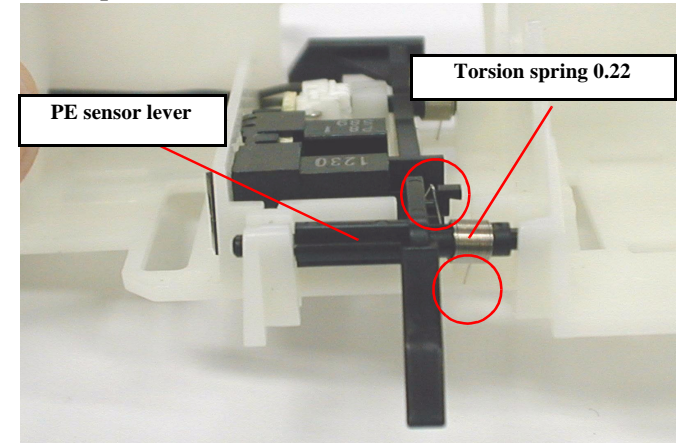

Figure 4-32. Torsion spring 0.22 for PE sensor lever

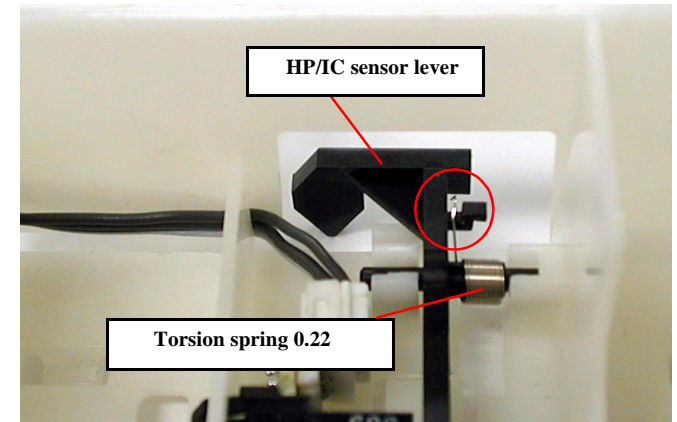

Figure 4-33. Torsion spring 0.22 for HP/IC sensor lever



- Make sure that the HP/PE/IC sensor cable is placed to the suitable groove on the LD roller shaft holder.

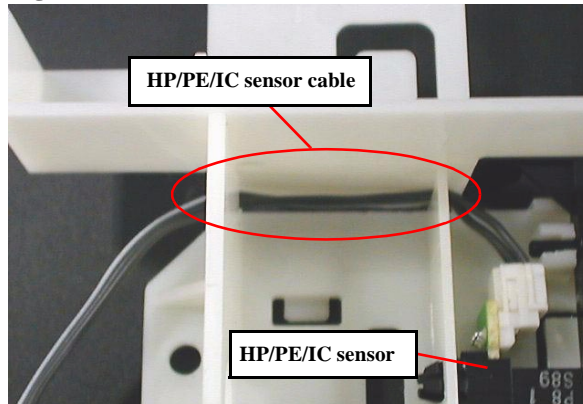

Figure 4-34. Sensor cable placing position (1)

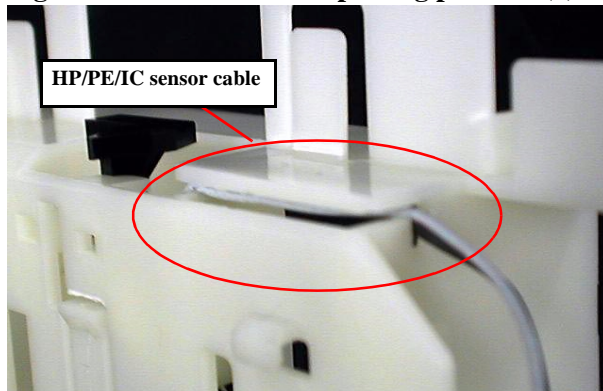

Figure 4-35. Sensor cable placing position (2)

- Make sure that the each sensor lever turn back smoothly by moving it after the sensor was assembled to the LD roller shaft holder.

4.2.9 Ink system unit removal (Cap & Pump unit)

1. Remove the Housing from the printer. (Section 4.2.1 Housing removal)
2. Remove the Waste drain ink pad from the printer. (Section 4.2.5 Waste drain ink pad unit removal)
3. Remove three screws (C.B.S. 3x6, F/Zn screw: 2pcs, C.B.S. TITE 3x6, R, F/Uc screw: 1pcs) securing the Ink system frame and the Cap assembly to the frame.

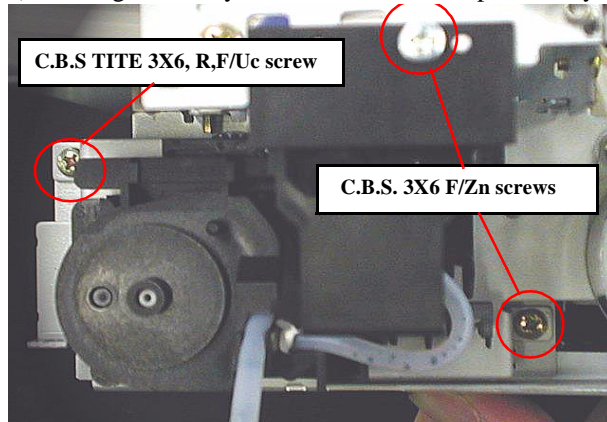

Figure 4-36. Removing three screws securing the Ink system

4. Remove the Ink system unit (Cap & Pump unit) carefully along with the PF motor & Ink system frame.

CAUTION



When the Ink system unit is removed, be careful that the gears do not come off from each shaft on the Ink system frame.

5. Release one hook for Cap assembly on the Ink system frame and take the Cap assembly out from the Ink system frame.
6. Disconnect the waste drain ink tube carefully from the bottom of the Cap assembly.

CAUTION



- Since the compression spring is included in the Pump assembly, watch out for the spring and the gear that pop out from the unit when the Pump assembly is removed from the Ink system unit.
- When replacing the cleaner head built in the Pump assembly, be careful of the following points.
 - 1) Do not touch the cleaner head with your bare hands. Wear gloves or use tweezers.
 - 2) Do not smear the head cleaner with oil or grease.
- When installing the Cleaner head, set the rubber side (black side) facing toward the right side of the frame.
- When installing the Cleaner head, set the two square cut offs on the Cleaner head into the two hooks on the Ink system.

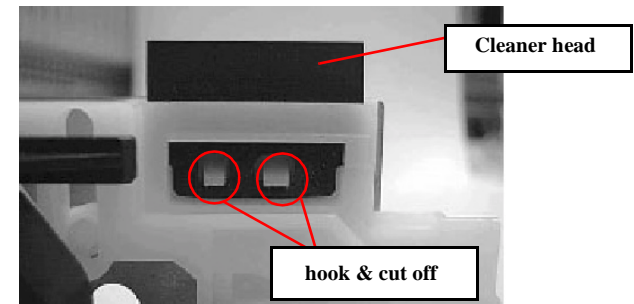

- When replacing the Cap Assembly, do not touch the sealing rubber portion of the Cap Assembly.
- The component parts in the Pump Assembly are not individually supplied as ASP. So please replace the whole Pump Assembly when replacing the Pump Assembly.
- Be careful not to crush or leave any stress on the ink tube connecting the pump assembly and the cap assembly.



- Make sure that all gears are set in each gear shaft on the Ink system frame. The Combination gear 9.6, 33.6 must be set first on the Ink system frame.

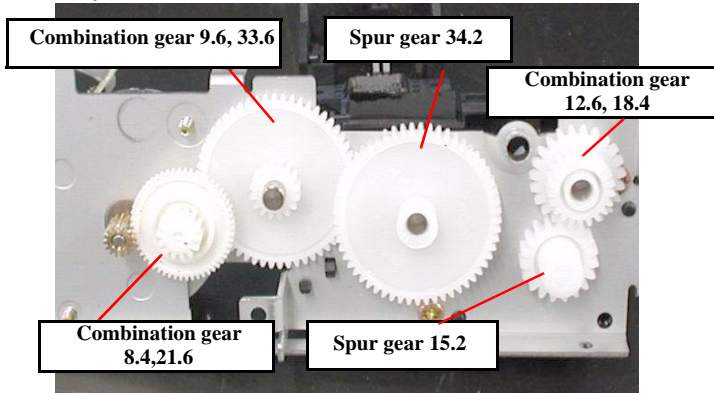

Figure 4-37. Gear engagement on the Ink system frame

- Make sure that the ink tube is placed along the following position.

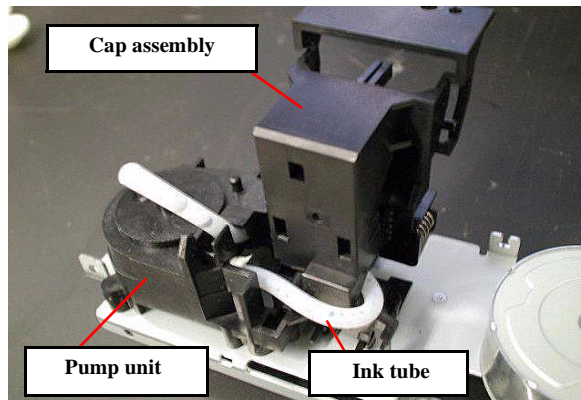

Figure 4-38. Ink tube placing position

- After installing the Pump Assembly, ensure that the cleaner parts move back and forth by rotating the Gear.



- Tightening torque for screw
 - C.B.S. 3x6 F/Zn screw for Ink system frame & Cap assy.: 9+/-1 kgf.cm
 - C.B.S. TITE 3x6 F/Uc screw for Ink system frame : 9+/-1 kgf.cm

4.2.10 Paper Eject Roller removal

1. Remove the Housing from the printer. (Section 4.2.1 Housing removal)
2. Remove three screws (C.B.S. 3x6, F/Zn screw, :2pcs, C.B.S. 3x5, F/CU screw) securing the Front frame to the Main frame.

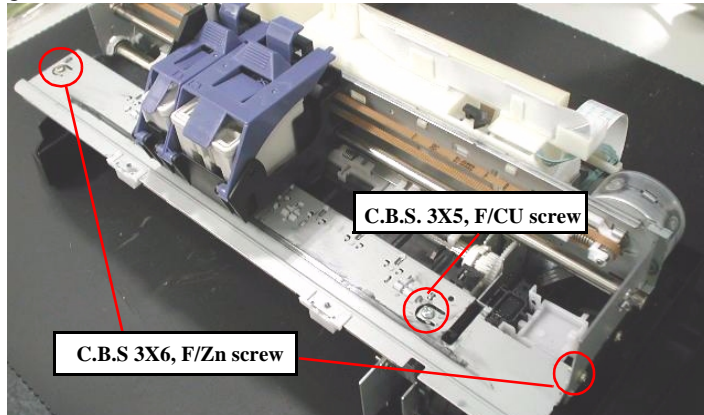

Figure 4-39. Removing the Front frame

3. Lift up the right side of the Front frame and slide it to the left side a little bit and then remove it.

CAUTION



When removing the Front frame, if the CR unit is out of the CR home position, the nozzle surface of the Printhead may come in contact with Paper guide front as soon as the Front frame is removed. This is because the CR unit is held with this frame. Therefore, be sure to set the CR unit in the CR home position before removing the Front frame. Otherwise, the dot missing problem may occur.

4. Slide the Paper eject roller carefully to the left side and remove the Paper eject roller to the forward.

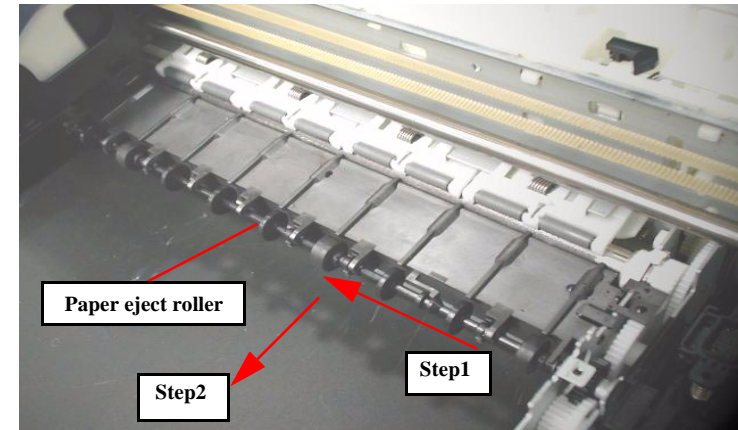

Figure 4-40. Slide the Paper eject roller

CAUTION



Do not damage the tooth of the Spur Gear 15, EJ, with the round hole on the Main frame.

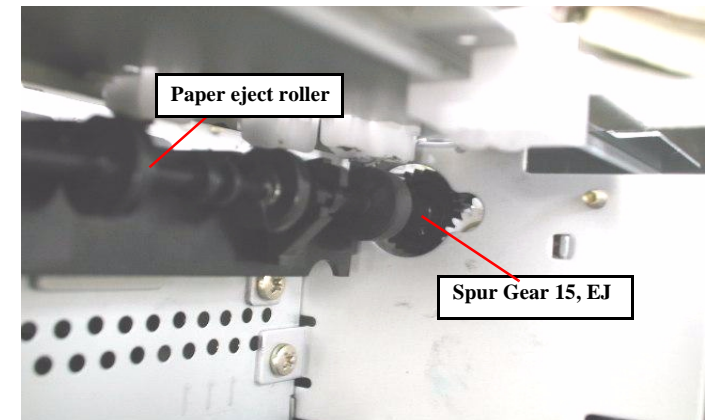

Figure 4-41. Spur Gear 15, EJ



- When you replace the Frame front, make sure to lubricate the specific amount of G26 to the Frame front. Refer to the Chapter 6 Figure6-8.
- When you replace the Paper eject roller with new one, make sure to lubricate the specific amount of G26 to the Spur gear 15, EJ. Refer to the Chapter 6 Figure6-10.



- Assemble the Paper eject roller in the following procedure.
 1. Set the Spur Gear 15, EJ to the cut out hole in the Main frame.
 2. Set the narrow portions of the shaft in the Paper eject roller to the shaft guide holders on the Front paper guide.
 3. Slide the Paper eject roller to the right side carefully and engage the gear with the Combination gear 12.6, 18.4 and the Spur gear 34.2.
- When you assemble the Front frame to the Printer mechanism, set the CR unit to the left side and assemble the Front frame from the right side. Be careful not damage the CR lock lever.
- Fasten the Front frame with C.B.S. Screw 3x6, F/Zn in the order of 1,2,3.

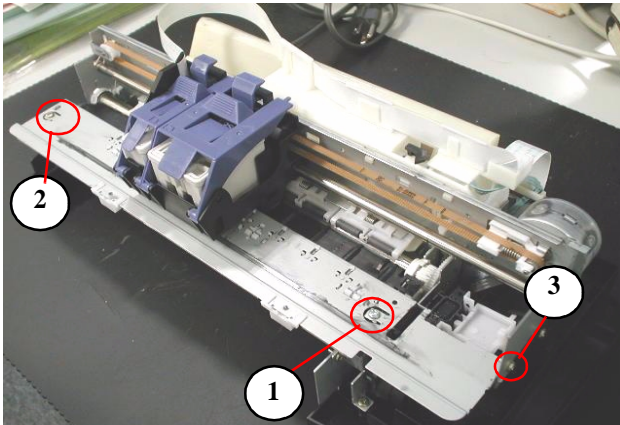

- Tightening torque for screw
 - C.B.S. 3x6 F/Zn screw for Front frame: 9+/-1 kgf.cm
 - C.B.S. 3x5 F/Uc screw for Front frame: 9+/-1 kgf.cm

4.2.11 Paper feed roller removal

1. Remove the Housing from the printer. (Section 4.2.1 Housing removal)
2. Remove the Paper Eject roller. (Section 4.2.10 Paper Eject Roller removal)
3. Release the PF grounding spring from the Main frame.

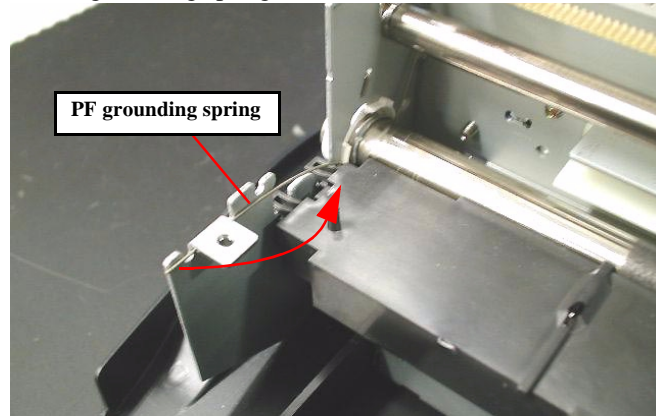

Figure 4-42. Releasing the PF grounding spring

4. Set the CR unit to the home position.
5. Release one hook located on the left edge of the Front paper guide.

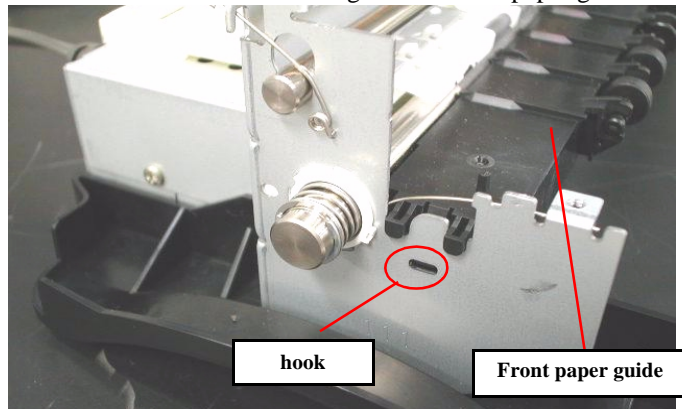

Figure 4-43. Release two hooks of the Front paper guide

6. Lift up the left edge of the Front paper guide while slanting the Front paper guide by pulling up its front edge, and then slide the Front paper guide to the left side after releasing the right hook on the Front paper guide.

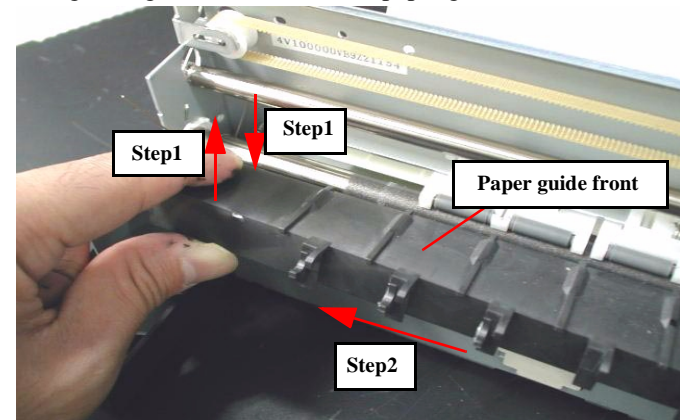

Figure 4-44. Remove the Front paper guide.

7. Fit the protrusions of the Left PF roller bushing to the notches in the frames as shown in the following figure and remove the PF roller fasten spacer with tweezers.

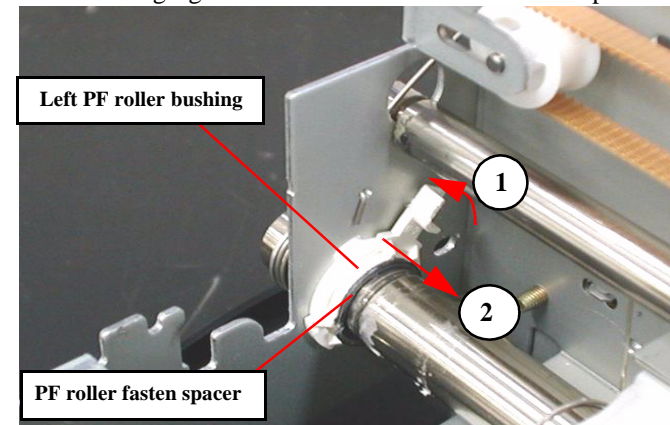

Figure 4-45.

Fit the protrusions of the Left PF roller bushing to each notches

8. Slide the Left PF roller bushing to right side as above figure Step 2.

9. Fit the protrusions of the Right PF roller bushing to the notches in the frames as shown in the following figure

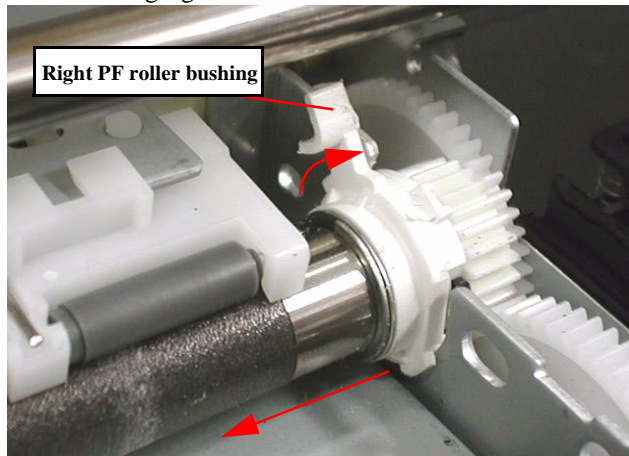

Figure 4-46. Fit the protrusions of the Left PF roller bushing to each notches

10. Slide the PF roller to the left side along with the both PF roller bushings and remove the PF roller from the printer mechanism.



- After assemble the PF roller, make sure that the dowel of the both left and right PF roller bushing holder fit in the cut hole of both frames.
- After assemble the Front paper guide to the printer mechanism, make sure that the hooks and the dowel pins on the Front paper guide is set to the fitting positions secure. Slide the Front paper guide to the right side by pushing it and make sure that the right hook on the Front paper guide is locked to the frame securely. If the Front paper guide is not fixed securely to the suitable position, it may cause the paper jam problem.

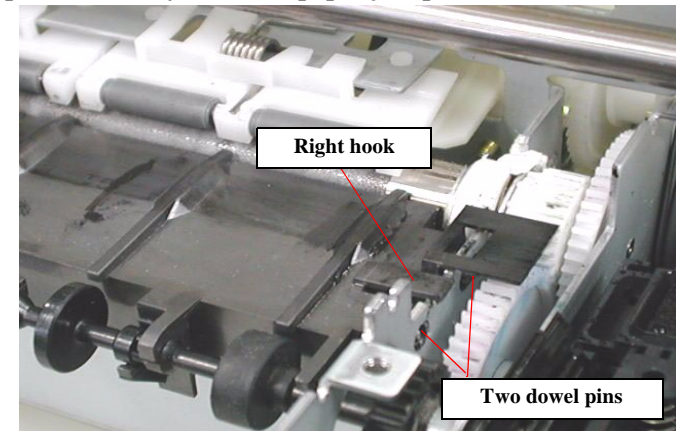

Figure 4-47. Front paper guide assembling notice



- When you replace the PF roller with new one, be sure to lubricate a specific amount of G-26 between the Left PF roller bushing holder and the left edge of the PF roller. Refer to Chapter 6 Figure6-5.



- When you assemble the Paper guide front to the Printer mechanism, set the CR unit to the home position and assemble the Paper guide front.
- When you assemble the Front frame to the Printer mechanism, set the CR unit to the left side and assemble the Front frame from the right side. Be careful not damage the CR lock lever.

4.2.12 CR unit removal

1. Remove the Housing from the printer. (Section 4.2.1 Housing removal)
2. Take the CR timing belt off the CR pinion gear by pushing the CR motor to the left.

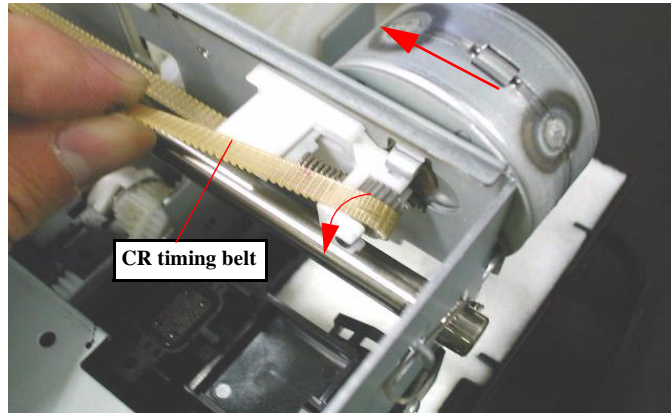

Figure 4-48. Taking the CR timing belt off

3. Release the Printhead FFC from the cable holders on the LD roller shaft holder. And disconnect the Printhead FFC from the connector CN4 on the Main board.

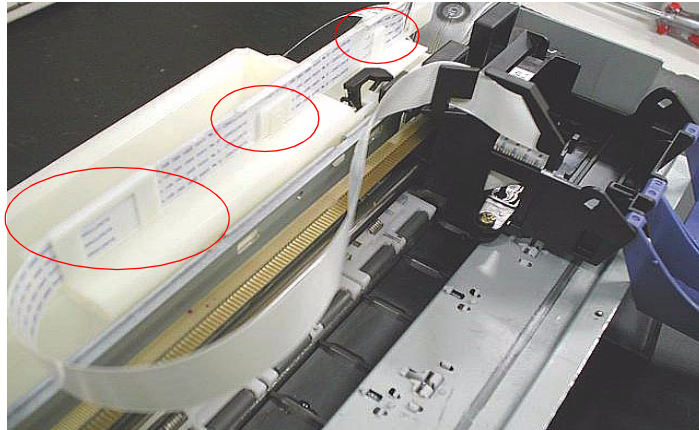

Figure 4-49. Taking Printhead FFC off

4. Release two CR guide shaft rod springs from the both hooks on the left and right sides of the Main frame.

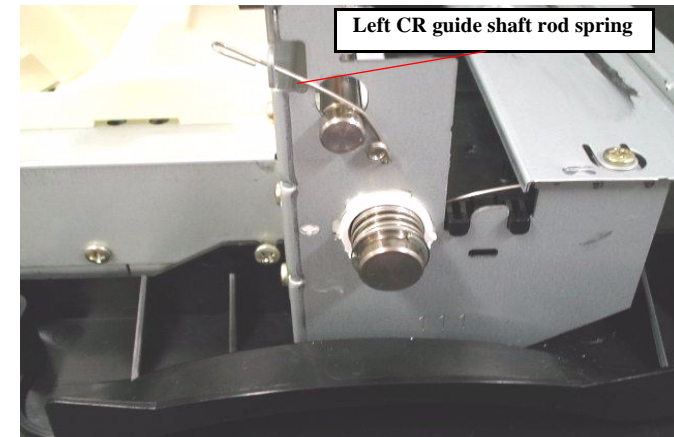

Figure 4-50. Release Left Rod spring for CR shaft

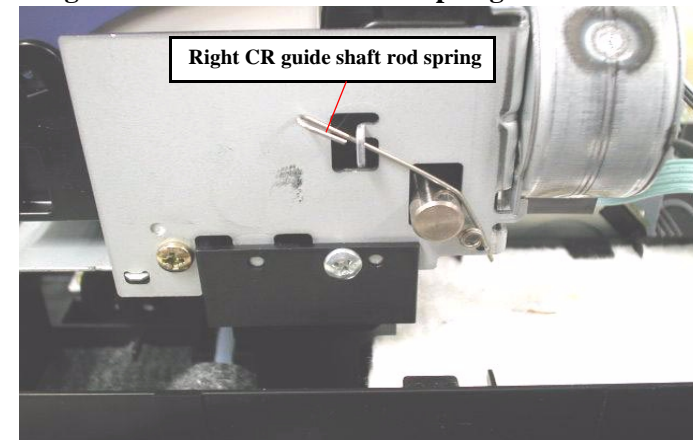

Figure 4-51. Release Right Rod spring for CR shaft

5. Pull the left edge of the CR guide shaft upward to align it with the round cutout portion. Then, holding the CR unit by hand, remove the CR guide shaft by sliding it to left or right.

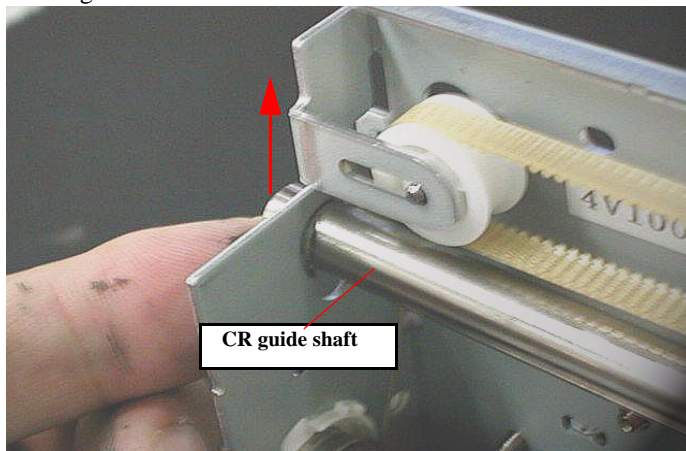

Figure 4-52. Removing the CR guide shaft

CAUTION



Remove the CR guide shaft while holding the CR unit by hand. If you remove the CR guide shaft without holding the CR unit, the nozzle surface of the Printhead may come in contact with the Paper guide front, which causes the dot missing problem.



- Unlike the previous products, the oil pad is not built in the CR unit.
- Make sure that the tips of the CR guide shaft rod springs are set in the holes in the Main frame.
- Make sure that the CR guide shaft rod springs are correctly set in the suitable position. Refer to Figure 4-50, Figure 4-51.
- If you disassemble the CR unit after removing the CR unit from the printer, make sure that the CR Grounding plate is assembled in the suitable position in the CR unit. Refer to Figure 4-53.
- Make sure that the CR slider is assembled on the CR unit.

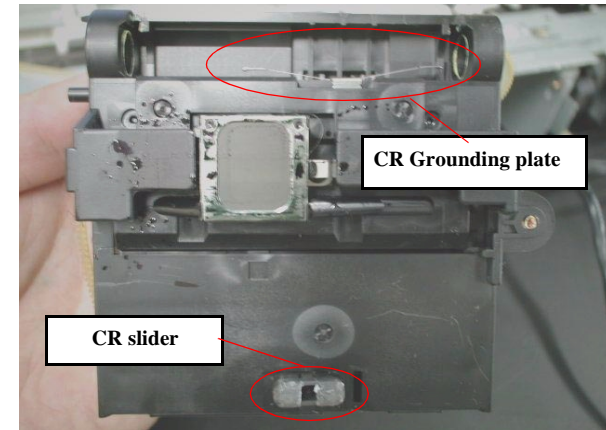

Figure 4-53. Grounding plate assembling position

- If you remove the Printhead from the CR unit, make sure that the Head grounding plate is set in the CR unit. Refer to Figure 4-7.
- Make sure that the groove on the CR guide shaft must be set to the left side.



- If the CR unit is disassembled or replaced with a new one, make sure that the CR timing belt is set in the assembling groove correctly as following figure.

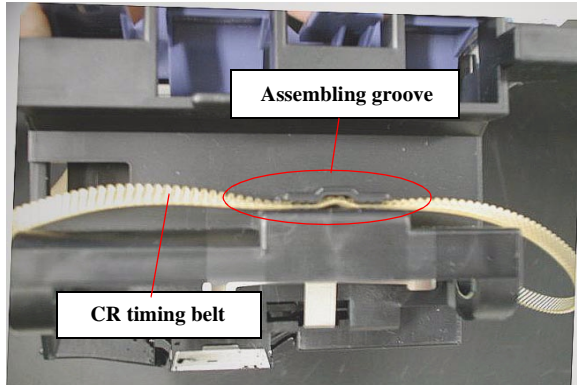

Figure 4-54. CR timing belt setting position



- When you replace the CR unit with a new one, lubricate it with the suitable amount of the G-55 grease by the specified position. Refer to Chapter 6 Figure 6-4.
- When you replace the CR Pulley shaft with new one, lubricate it with the suitable amount of G-26 grease by the specific position. Refer to Chapter 6 Figure6-6.
- When removing or replacing the CR unit with a new one, adjust the Gap (Bi-d). Refer to Page116.

4.2.13 Disassembling ASF frame unit

1. Remove the Housing from the printer. (Section 4.2.1 Housing removal)
2. Remove the LD roller shaft holder unit (Section 4.2.7 LD Roller removal)
3. Remove two screws (C.B.S.-TITE (P4), 3x6, F/Zn screw, C.B.S. Screw 3x6,F/Zn + Plain washer 3.2 x1 x 7,F/Zn) securing the ASF frame unit and remove the ASF frame unit from the printer mechanism

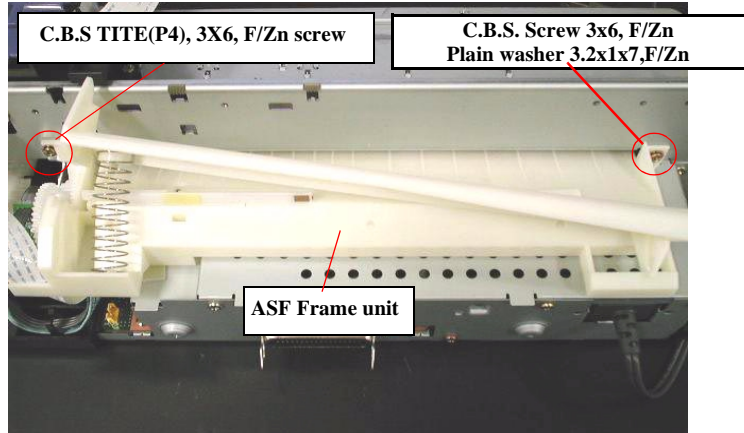

Figure 4-55. Removing the screws securing the ASF frame

4. Remove the following gears from the ASF frame.
 - Combination gear 11.2, 32.4
 - Combination gear 22.4, 32
 - Change lever unit

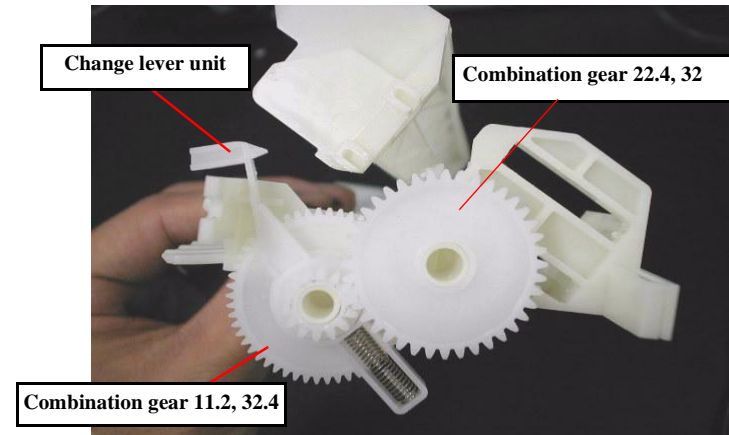

Figure 4-56. Removing the Gears from ASF frame unit

5. Remove the Compression Spring 2.67 located between the ASF Frame and the Hopper, and remove the Hopper from the ASF frame.

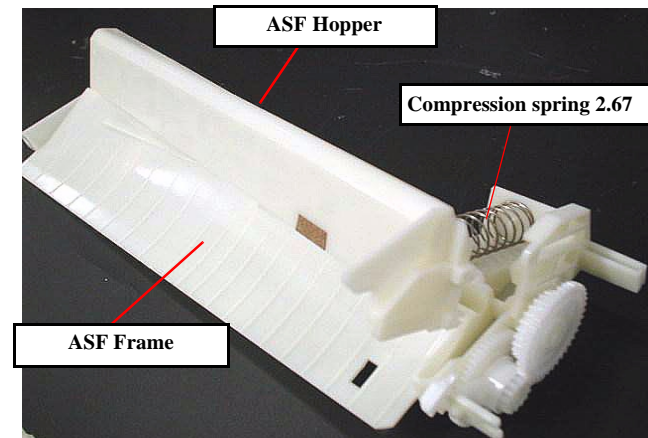

Figure 4-57. Removing the Compression spring 2.67

6. Remove the Torsion spring 25.7 from the bottom of the ASF frame and the Pad holder (Paper return plate).

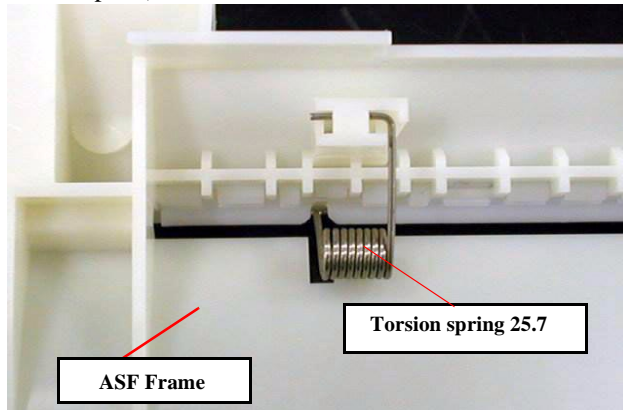

Figure 4-58. Removing the Torsion spring 25.7

7. Remove the Pad holder (Paper return plate) from the ASF frame.

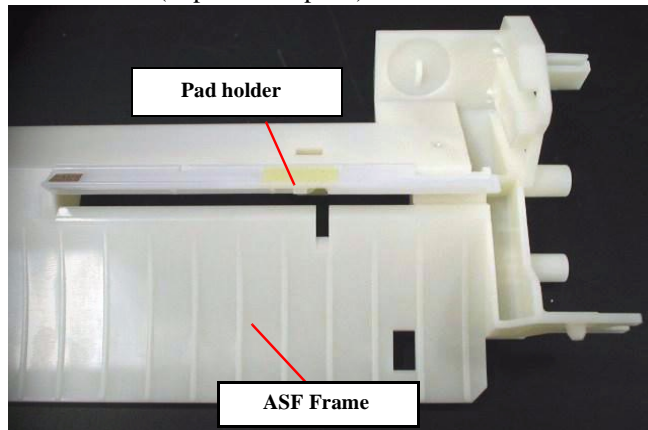

Figure 4-59. Removing the Pad holder (Paper return plate)



- Make sure that the each tip of the Torsion spring 25.7 is set in the slot of the Pad holder and ASF frame. Refer to Figure 4-57.
- Make sure that the Pad holder moves smoothly after assembling it to the ASF frame.
- Make sure the change lever setting position. Refer to following figure.

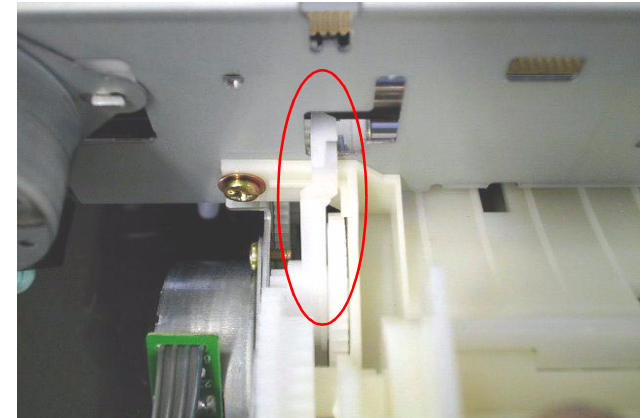

Figure 4-60. Change lever setting position



- When you replace the ASF frame or Hopper with the new one, make sure to lubricate the specific amount of G26 into the groove on ASF frame. Refer to Figure 6-7 & Figure 6-9 in the Chapter 6.
- Fasten the ASF unit C.B.S. TITE (P4) 3x6, F/Zn screw (left screw in the following figure), Plain washer 3.2x1x7, F/Zn & C.B.S 3x6, F/Zn screw (right screw in the following figure) in the order of following figure.

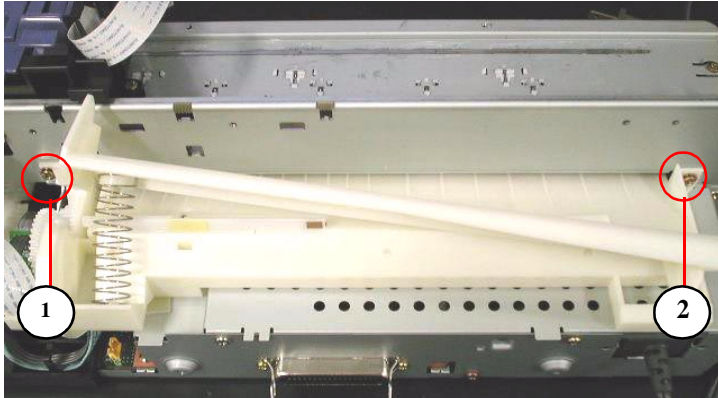

Figure 4-61. ASF fixing screws fastening order

- Tightening torque for screw
 - C.B.S. 3x6 F/Zn screw for ASF : 9+/-1 kgf.cm
(right screw in above figure)
 - C.B.S. TITE(P4) 3x6, F/Zn screw for ASF: 9+/-1kgf.cm
(left screw in above figure)

CHAPTER

5

ADJUSTMENT

5.1 Overview

This section describes the procedure for adjustments required when the printer is disassembled and assembled for repair or service.

5.1.1 Required Adjustment

Table 5-1 lists all the necessary adjustments for this printer. If any service listed in this table is carried out, all adjustments corresponding to that service item should be performed to ensure proper operation of the printer.

Table 5-1. Required Adjustment

Performance Priority	1	2	3	4	5
Replacing parts/Service item	Initial Ink Charge	Head ID Setting	Bi-D Adjustment	USB ID Input	Ink pad Counter reset
Replacing the Main Board.	NA	①	②	③	NA
Replacing the printhead unit.	①	②	③	NA	NA
Replacing the CR motor.	NA	NA	①	NA	NA
Replacing or removing the CR assembly.	NA	NA	①	NA	NA
Replacing the Waste drain ink pad	NA	NA	NA	NA	①

NOTE: “O”: Required Adjustment. The number in the circle shows the required adjustment order.

“NA”: Not applicable.

NOTE: Following adjustments are not required on this product.

- Platen Gap adjustment
- Head Angular adjustment.

NOTE: When the Main board is replaced with new one, you may have to replace the following parts also in case the EEPROM parameter backup function is not available on the defective main board.

- * Waste drain ink pad
- * Both Black & Color Ink Cartridge

This section describes the detailed procedures of each adjustment by Adjustment Program.

In this printer, it is necessary to set the adjusting information for each printer mechanism in order to maintain consistent printing function and quality, eliminating differences of each printer mechanism's characteristics. Therefore, in case that the combination of the printer mechanism and main board changes or the print head is replaced during the repair service, you must set and save the correct information to the MAIN board, using the exclusive adjustment program.

This section describes the detailed procedures of each adjustment by Adjustment Program.



In case any parts is removed and assembled on the repair product while running the Adjustment program, turn off the printer certainly.

5.1.2 Adjustment Program feature

This adjustment program is exclusive for Windows: the OS that allows operation of this program is Windows 98. The following shows programs included in this program.



- This adjustment program operates only under Windows 98: This program does not operate under DOS or Windows 3.X, 95, NT.
- This adjustment program automatically install the appropriate program according to your OS.
- Perform this adjustment program using USB I/F port.

This adjustment program is composed of following two main programs.

□ **Individual service adjustment program**

This program provides you the adjustment item individually as same as the previous adjustment program. The available functions are as following table.

Table 5-2. Individual service adjustment program

No.	Main Menu	Service
1	Adjustment	Head ID input
		Bi-d adjustment
		USB ID input
2	Maintenance	Head cleaning
		Initial ink charge
		Refurbishment for DOA
		Protection counter check / reset
3	A4 check pattern print	EEPROM check / write
		A4 check pattern print

The user interface of the main menu on this program is shown below.



Figure 5-1. Individual service adjustment program main menu

□ Sequential repair service program

This program provides you the suitable adjustment order in the program according to the repair parts. The available functions are as following table.

Table 5-3. Sequential repair service program

Repair item	Included Adjustment item	
1	Printhead removal	Head Cleaning, Nozzle check, Bi-d adjustment.
2	Printhead replacement	Initial charge, Head ID Input, Nozzle check, Bi-d adjustment.
3	Main board replacement	EEPROM Back up, Load on EEPEOM or Head ID input, Bi-d adjustment, USB ID Input, Ink pad replacement, I/C replacement (default setting, market setting)
4	CR Unit replacement or removal	Bi-d adjustment
5	CR Motor replacement	Bi-d adjustment
6	Printer mechanism replacement	Initial ink charge, Head ID input, Nozzle check, Bi-d adjustment
7	Waste Ink pad replacement	Waste ink pad counter reset

The user interface of the Sequential repair service program is as following figure.



Figure 5-2. Sequential repair service program main menu

5.1.3 Adjustment Program Installation Procedure

This adjustment program is in the 3.5 2HD FD. The first FD is the installer disk. When you execute Setup.exe, the installation of the program will be started under Windows 98. After installation is completed, the Stylus COLOR 580 icon will be automatically made in the program menu. Go “Start” -> “Program” and click the icon to start this program.

5.1.4 Adjustment Program Initial Setting menu

You have to input the following four items before entering the adjustment main menu.

- Model name (Stylus COLOR 580)
- Interface setting (EPUSB1, EPUSB2, EPUSB3)
- Market (World, ESP, EIO)
- Program type (Individual service adjustment program or Sequential repair service program)

Follow the procedure below to input the initial settings.

1. When you run this program, the following menu appears. Select the Stylus COLOR 580 in the screen below.

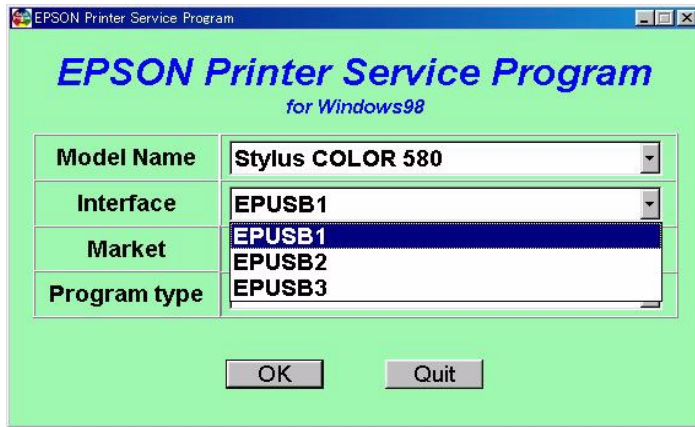

Figure 5-3. Model Name Selection

NOTE: This printer stores model name in the PROM. Therefore, even you select the model name in the screen above, model name will not stored in the EEPROM. Selecting model name in the screen above determines respective special command for each model.

2. Select the USB port number which you connect the printer to your PC as above Figure 5-3.

3. Select the suitable destination in the market menu. “World” is the standard destination setting except the ESP and EIO. The waste drain ink pad life for ESP & EIO product is different from World standard. So, you have to select the suitable destination in order to set the suitable waste drain ink pad life. This setting is used when the waste drain ink pad counter is reset or the main board is replaced with new one in the adjustment program.

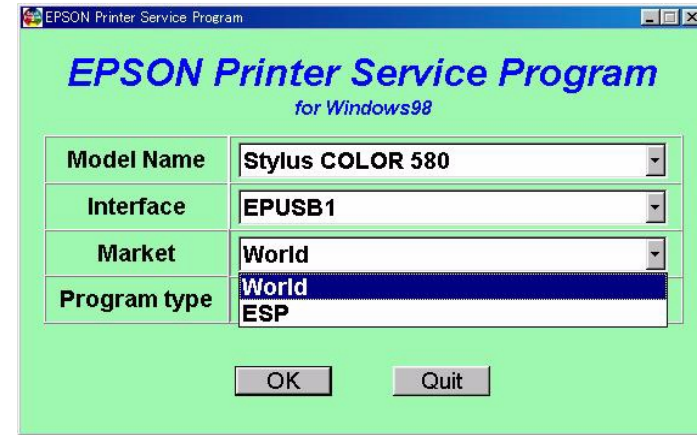

Figure 5-4. Destination Setting

4. Select the Program type which you will run in the menu.

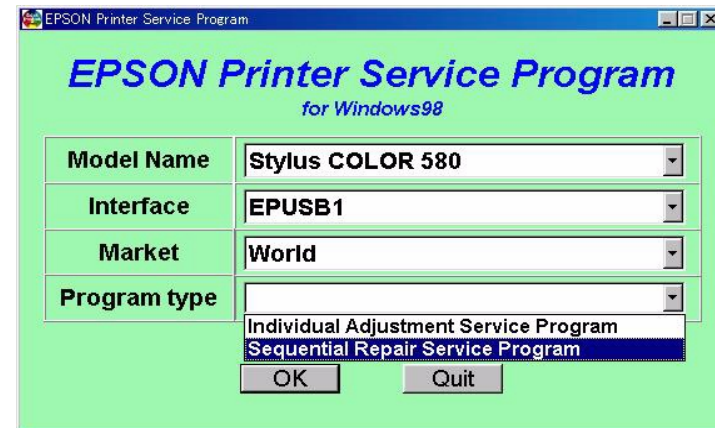

Figure 5-5. Program type selection.

5.2 Sequential Repair Service Program feature

5.2.1 Feature

In this manual, we will explain mainly about the Sequential repair service program. This program provides you the suitable adjustment order by selecting the repair item in the Sequential repair service program main menu. In this program, following 7 items are listed.

- Printhead removal
- Printhead replacement
- Main board replacement
- CR unit replacement or removal
- CR motor replacement or removal
- Printer mechanism replacement
- Waste ink pad replacement



Figure 5-6. Sequential repair service program main menu

The “Adjusted item” in the right column shows you the adjusted item which executed in this program and it is easy to confirm the adjusted value. Additionally, this program runs under the D4 (IEEE-1284.4) protocol. So, this program can get the several error

status even if the printer is error condition, and can control the printer under the error condition. Following explain you the common function of the Sequential repair service program.

Quit

If you want to exit this program, click the “Quit” button. Following menu is displayed on the screen. And clicking the “Quit” Button in the following menu exit the adjustment program completely. Clicking the “Next” button returns to the Top menu (Initial setting menu) of Figure 5-3.



Figure 5-7. Quit function

Menu

This function is used to stop the adjustment in the each sequential program and clicking this “Menu” button returns to the Sequential repair service program main menu of the Figure 5-6.

Get status

This function is used to get the printer status and following figure is displayed on the screen by clicking the” Get status” button. This function can get the printer status even if the printer is error condition except the main logic circuit failure, and control the printer by using the D4 mode functions.



Figure 5-8. Get status function

In the next page, we will explain the each function of the “Get Status” function.

1) Inquire

Clicking this button, you can get the following printer status.

- Ink level of the each ink cartridge
The available remaining ink amount is displayed with figure of Ink cartridge.
- Printer status
The status monitor can get the following 7kinds of the printer status depend on the printer status.
* Maintenance error, * Paper jam, *Paper out * Fatal error, * Ink low, *Ink end, * Printing

2) Close

Clicking this button, you can close the Status monitor and can return to the adjustment menu.

3) D4 mode function

You can perform the following items directly from this menu.

- Execute Head cleaning
The suitable printhead cleaning is performed based on the cleaning order. See the “Ink Sequence” on page 40.
- Print nozzle check pattern
This function performs the nozzle check printing.
- Exchange ink cartridge
In this function, you can select which ink cartridge you will exchange, and can perform the I/C exchange sequence even if the printer is ink low/end condition.

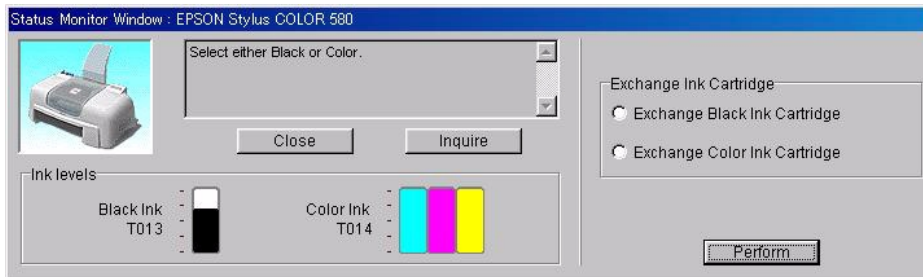

Figure 5-9. Exchange ink cartridge

- Reset the printer
This reset function is almost same as the Power on reset and following items are reset by this function.
* Initialize printer mechanism.
* Clears the input data buffer
* Clears the print buffer
* Sets default values except I/F setting.
- Check the Protection counter (Waste drain ink pad counter check.)
In this function, you can check the Waste drain ink pad counter. We recommend to use this function to check the counter after complete the repair.

Basically, you have to click the “Get Status” button to get the printer status.

But, when any error condition is detected by this program on the connected printer, error status is displayed automatically as following figure.



Figure 5-10. Error status of Status menu



This program’s status monitor dose not display the “Paper out” error status in the Bi-d adjustment even if the paper is out in the ASF. When the paper is out in the ASF, this program continues to send the paper feed command until the paper is set in the ASF.

5.2.2 Printhead removal

When you remove the printhead from the printer mechanism and reinstall the removed printhead to the printer mechanism, this repair item should be selected in the Sequential repair service program.

1. Install the removed printhead to the CR unit on the repair printer mechanism.
2. Select the “Printhead removal” in the Sequential repair service program. Following Printhead removal top menu is displayed.

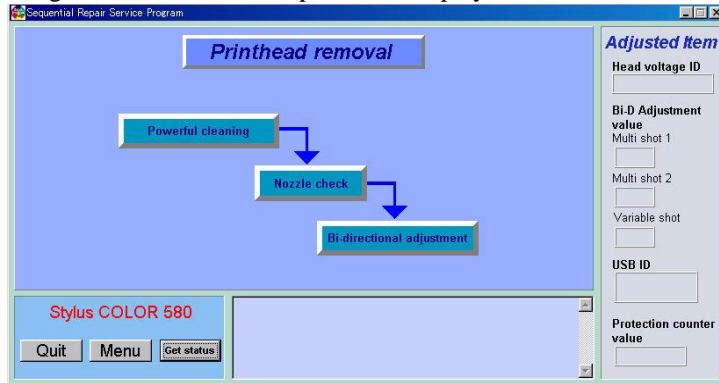

Figure 5-11. Printhead removal program menu

3. Clicking the “Powerful cleaning” displays the following message and instructs you to install the brand-new I/C.



Figure 5-12. Confirmation message for the brand-new I/C installation

4. Click the “Yes” button starts the Powerful CL in order to eject the air bubbles from the printhead cavity. In this function, CL1’ is performed and about 1/8 ink of the brand-new Black I/C and 1/18 ink of the brand-new Color I/C are consumed.

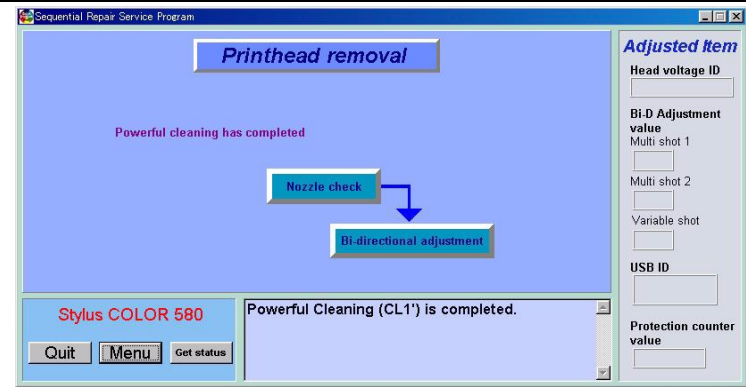

Figure 5-13. Powerful cleaning

5. For the next step, click the “Nozzle check” to check the nozzle condition. After print the nozzle check pattern, following message is displayed.

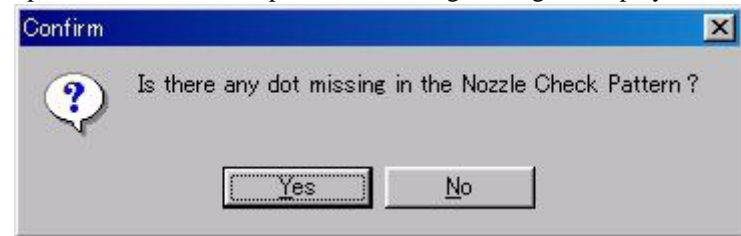

Figure 5-14. Confirmation message for nozzle condition

6. If any segment in the nozzle check pattern has dot missing, click the “Yes” button to perform the powerful cleaning again. If all segment is printed correctly, click the “No” button to proceed the Bi-directional adjustment function.

- Click the Bi-directional adjustment to adjust the Bi-directional printing alignment. In the following menu, select the suitable print mode which you want to adjust, and click the "Print" button. Basically, select all printing mode for the 1st adjustment.

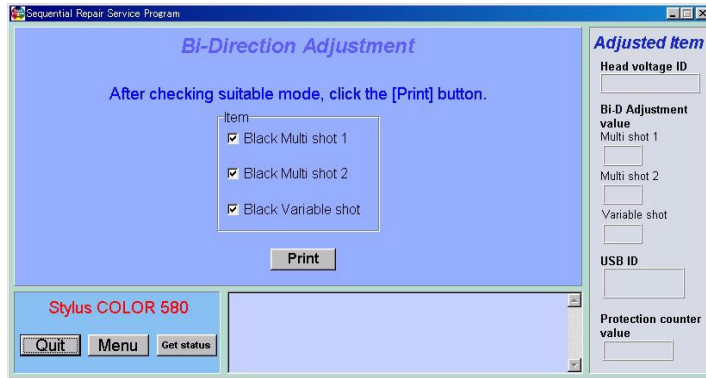

Figure 5-15. Bi-d adjustment menu

- By clicking the "Print" Button in the above menu, following message is displayed. Set the paper in the ASF by following the message and click the "OK" button to start the printing for the Bi-directional alignment check pattern.

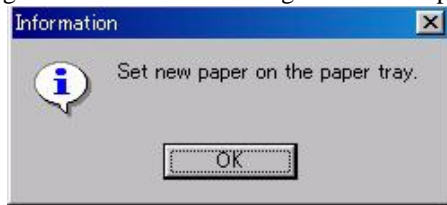

Figure 5-16. Setting the new paper in the ASF



The current setting is printed at the center of the 5 kinds of the Bi-directional adjustment pattern. So, check the center pattern and select the most aligned pattern number.

- Select the most aligned pattern number in the printed pattern and input the number in the following menu.

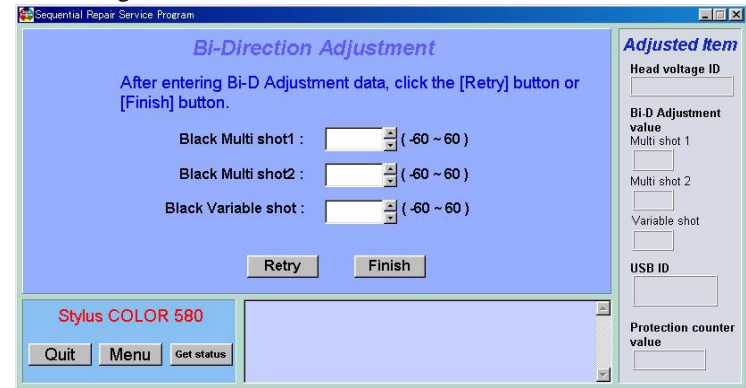

Figure 5-17. Input the suitable pattern number

- After input the suitable pattern number, click the "Retry" button to return the Bi-directional check alignment + pattern print menu of Figure 5-15. When the "Print" button is clicked for the 2nd check pattern printing, following message is displayed. When the same paper used for 1st check pattern printing is set in the ASF and click the "OK" button in the following message, printer advances the paper automatically under the 1st printed pattern and the 2nd check pattern is printed from the position.



Figure 5-18. Setting the same paper in the ASF

- Repeated Step 7) to Step 10) to adjust the Bi-directional print alignment completely. If you exit this Bi-directional print alignment program, click the "Finish" button on the above Figure 5-17 or Click the "Menu" button.

12. Click the “Get status” button and check the waste drain ink pad counter in this function. If the waste drain ink pad counter is around the limit counter, replace the pad and reset the counter according to the customer request.
13. Click the “Menu” button to exit the program.

5.2.3 Printhead replacement

When you replace the printhead with new one, this repair item should be selected in the Sequential repair service program.

1. Replace the Printhead with the new one and select the “Printhead replacement” item in the Sequential repair service program menu. Following “Printhead replacement” menu is displayed.

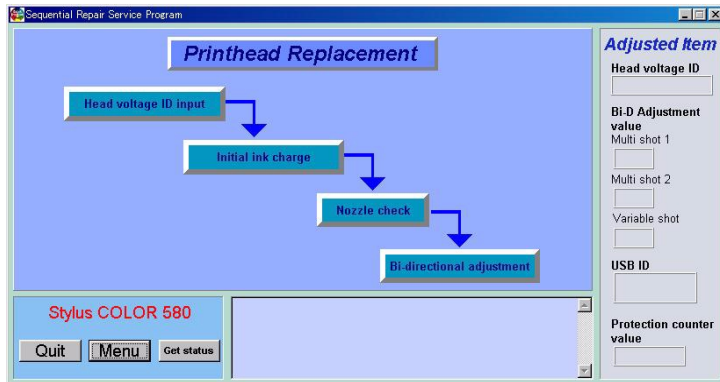

Figure 5-19. Printhead replacement program menu

2. Click the “Head voltage ID Input” in the above menu. The screen below appears. Input the 6digits code by referring the head ID label stacked on the Printhead and click the “OK” button.

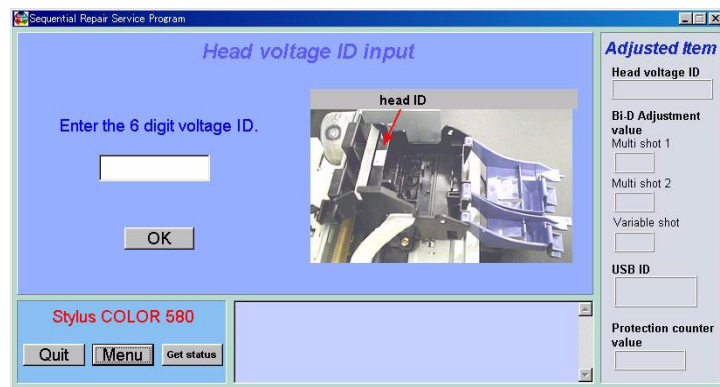

Figure 5-20. Head voltage input menu

NOTE: If you input the incorrect digits code for the Head voltage ID menu, following error message is displayed.

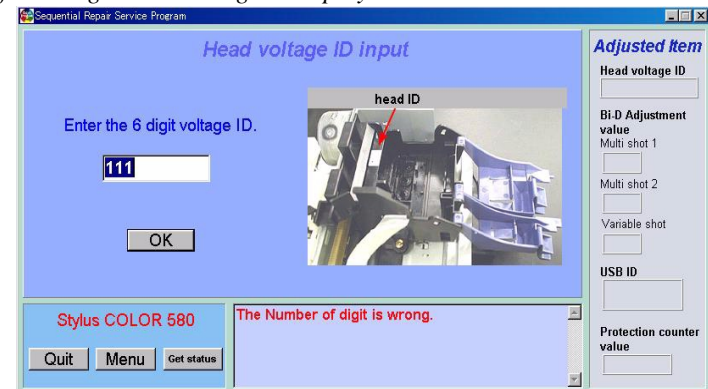

Figure 5-21. Error message for incorrect Head voltage input (1)

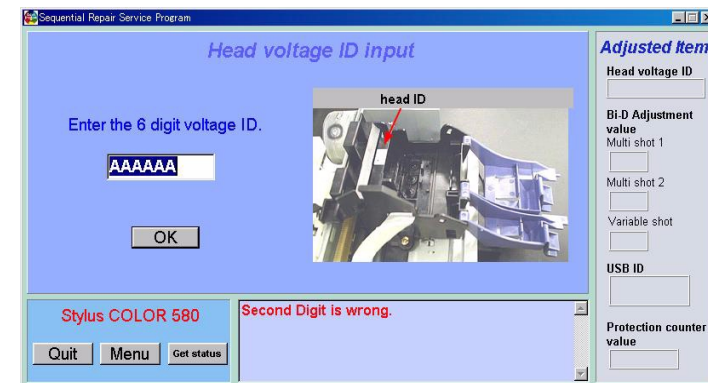

Figure 5-22. Error message for incorrect Head voltage input (2)

- After complete the Head voltage ID input, the following screen is displayed.

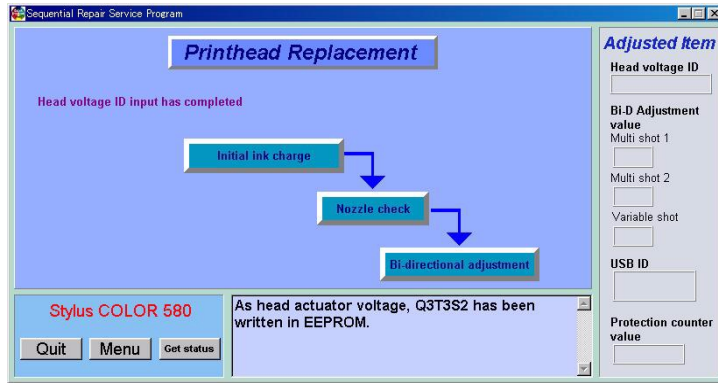

Figure 5-23. Initial ink charge function

- For the next step, select the “Initial ink charge” in the above menu. Following message is displayed. Install the brand-new I/C to the printer by following the message.



Figure 5-24. Confirmation message for brand-new I/C installation

- After install the brand-new I/C, click the “OK” button to perform the Initial ink charge in order to fill out the printhead cavity with the ink.
In this sequence, about 1/2 ink of the brand-new black I/C and 1/6 ink of the brand-new color I/C are consumed. And it takes about 110 seconds.
 If you click the “No” button, the program proceed the I/C exchange sequence.

- After complete the Initial ink charge, following message is displayed.

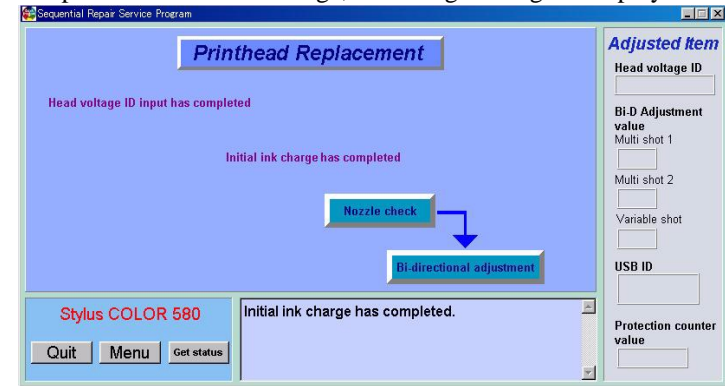

Figure 5-25. Nozzle check pattern function

- Click the “Nozzle check” in the above menu to check the nozzle condition. After print the nozzle check pattern, following message is displayed.

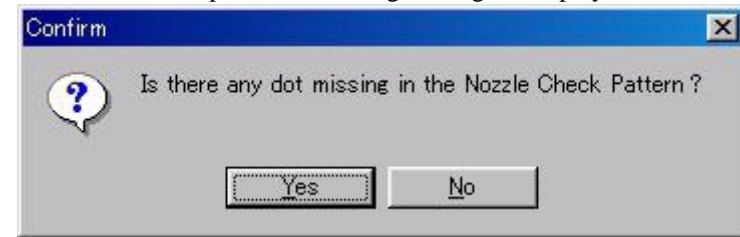

Figure 5-26. Confirmation message for nozzle condition

- If any segment in the nozzle check pattern is missing, click the “Yes” button to perform the powerful cleaning. If all segment is printed correctly, click the “No” button to proceed the Bi-directional adjustment function.

- Click the Bi-directional adjustment to adjust the Bi-directional printing alignment. In the following menu, select the suitable print mode which you want to adjust, and click the “Print” button. Basically, select all printing mode for the 1st adjustment.

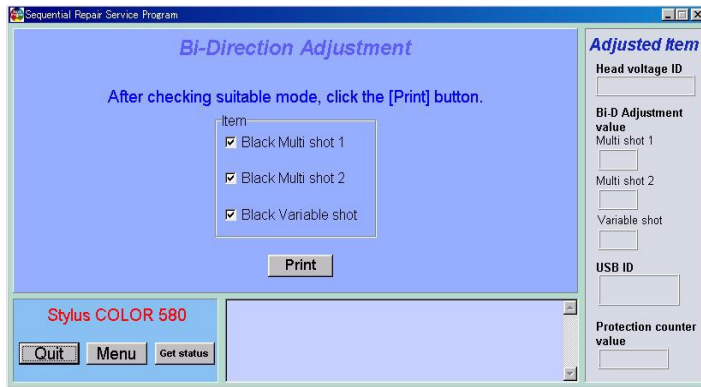

Figure 5-27. Bi-d adjustment menu

- By clicking the “Print” Button in the above menu, following message is displayed. Set the paper in the ASF by following the message and click the “OK” button to start the Bi-directional check pattern printing.



Figure 5-28. Setting the new paper in the ASF



The current setting is printed at the center of the five Bi-d adjustment patterns. So, check the center pattern and select the most aligned pattern number.

- Select the most aligned pattern number in the printed pattern and input the number in the following menu.

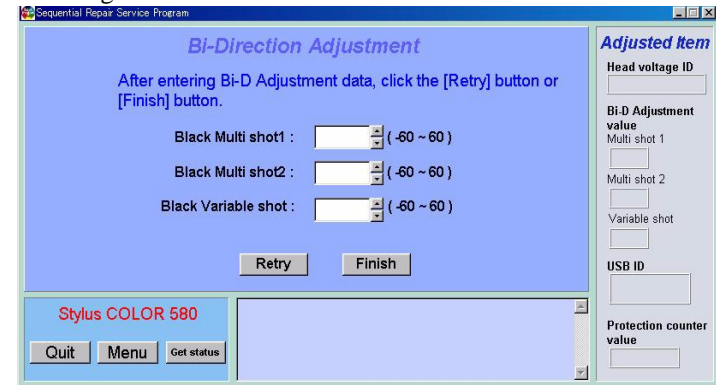

Figure 5-29. Input the suitable pattern number

- After input the suitable pattern number, click the “Retry” button to return the Bi-directional check pattern print menu of Figure 5-27. When the “Print” button is clicked for the 2nd check pattern printing, following message is displayed. When the same paper used for 1st check pattern printing is set in the ASF and click the “OK” button in the following message, printer advances the paper under the 1st check printed pattern and the 2nd check pattern is printed on from the position.



Figure 5-30. Setting the same paper in the ASF

- Repeat Step 9) to Step 12) to adjust the Bi-directional print alignment completely. If you exit this Bi-directional print alignment program, click the “Finish” button on the above figure or click the “Menu” button.
- Click the “Get status” button and check the waste drain ink pad counter in this function. If the waste drain ink pad counter is around the limit counter, replace the pad and reset the counter according to the customer request.
- Click the “Menu” button to exit the program.

5.2.4 Main board replacement

When you replace the main board with new one, this repair item should be selected in the Sequential repair service program.

NOTE: Before replace the defective main board, connect the printer to the PC and run this program to confirm the necessary logic circuit is active. If the CPU and I/F receiver IC, EEPROM, RAM is not broken, Status monitor will detect the Fatal error and displayed on the screen. In this case, EEPROM back up function may be available.

1. Connect the defective printer and check if the status monitor display the Fatal error.
If the status monitor display the Fatal error, click the “Close” button to proceed the next step. (Most of the case, the fatal error is displayed).

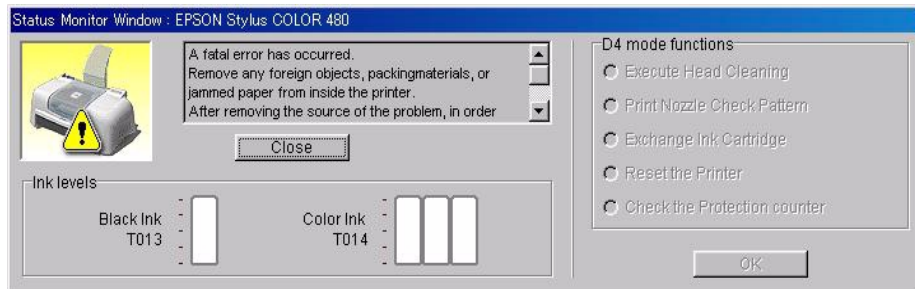

Figure 5-31. Close the Status monitor

2. Click the “Main board replacement” in the Sequential repair service program. The following menu is displayed.

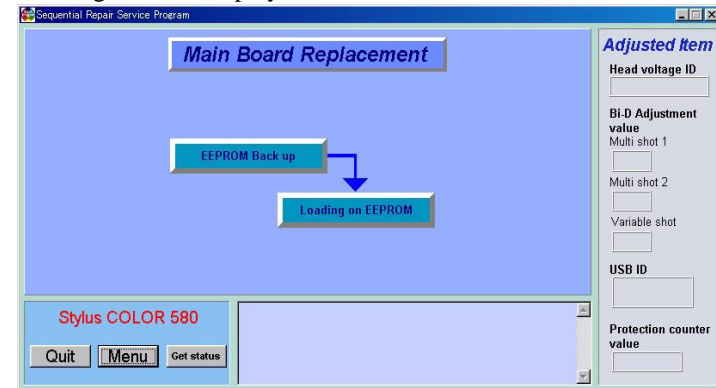

Figure 5-32. Click the Main board replacement

3. Click “EEPROM back up” to read out all EEPROM data from the defective main board. The program starts to check the EEPROM condition on the defective Main board by clicking the “OK” button in the following message display on the screen.



Figure 5-33. Check the EEPROM condition

- If the EEPROM is normal condition, following message is displayed. Click the “OK” button to start the EEPROM back up function.



Figure 5-34. Start EEPROM back up function

In case the following message is displayed, the EEPROM back up function is disable. Click the “OK” button to proceed the Step 9) to input the necessary data to the new main board manually.



Figure 5-35. EEPROM is defective.

- When the EEPROM back up is completed, following message is displayed. Replace the defective main board with new one by following the message and click the “OK” button after the replace the Main board.



Figure 5-36. Replace the defective main board with new one

- Turn on the printer and click the “Load on EEPROM “to copy the EEPROM back up data to the new main board. It takes about 30 seconds to complete the EEPROM data copy.

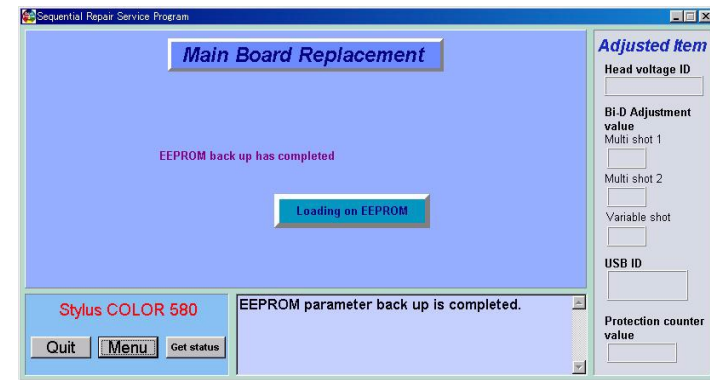

Figure 5-37. Copy the EEPROM data to the new main board.

- When the EEPROM back up data is copied successfully, following message is displayed and the necessary service items for Main board replacement is completed. Click the “Menu” button to exit this program.

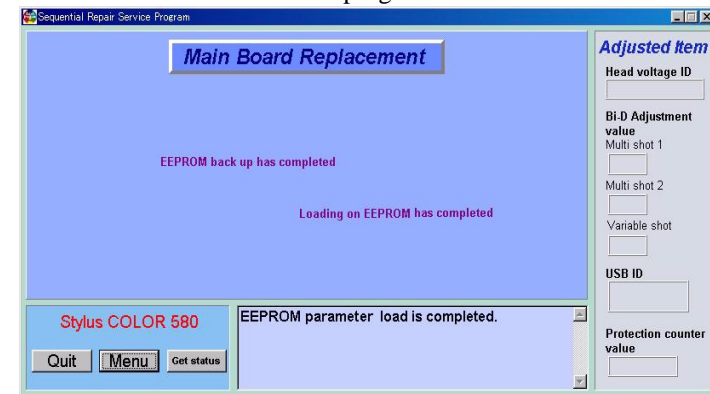

Figure 5-38. EEPROM back up data copy succeed

- Click the “Get status” and check the Waste drain ink pad counter in this function. If the waste drain ink pad counter is around the limit counter, replace the pad and reset the counter according to the customer request.

- In case the EEPROM is broken on the defective main board and the EEPROM back up/ copy function is not available, replace the Main board with new one by following the message and click the “OK” button.



Figure 5-39. Replace the defective main board with new one.

- Click the “OK” button to proceed the following adjustment menu after turn on the printer.

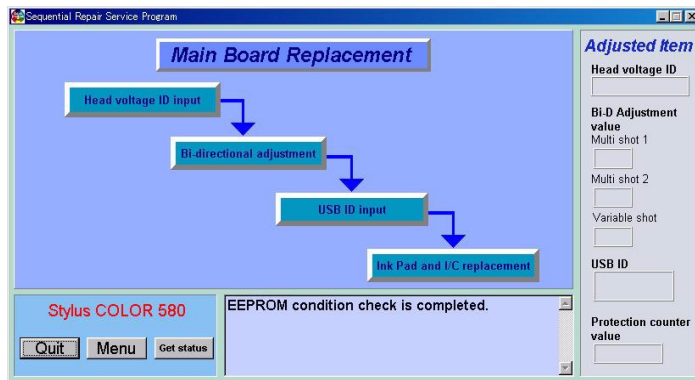

Figure 5-40. Required adjustment item for main board replacement

- Carry out the “Head voltage ID input”, “Bi-d Adjustment” and “USB ID Input” by following the displayed procedure.

- After complete the Head ID input and Bi-d adjustment items, click the “Ink pad replacement” button. Replace the Waste drain ink pad with new one by following the message displayed on the screen. Turn on the printer after replace the Waste drain ink pad with new one and click the “OK” button to write the market setting and the default setting into the EEPROM.



Figure 5-41. Replace the Waste drain in pad & Set the market setting

- Click the “I/C replacement” button to replace the both I/C with new one. Replace the both I/C with new one by following the message.

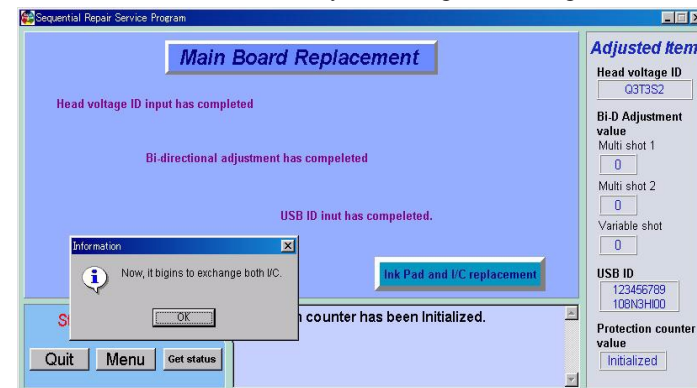

Figure 5-42. Replace the both I/C with new one.

- Click the “Menu” button to exit the program.



- In case the EEPROM back up / copy function is not available and main board is replaced with new one, the new main board dose not have the current Ink counter and waste drain ink pad counter. So, you have to replace the Waste drain ink pad and both I/C with new one.



The current setting is printed at the center of the five Bi-d adjustment patterns. So, check the center pattern and select the most aligned patter number.

5.2.5 CR unit replacement or removal

1. After you replace or remove the CR unit in the service activity, Click the “CR unit replacement or removal” in the Sequential repair service program.

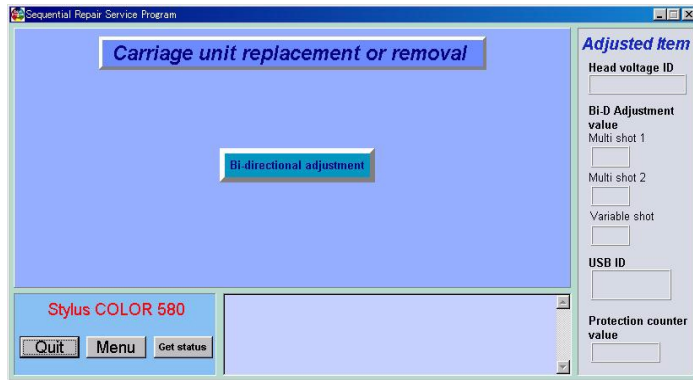

Figure 5-43. CR unit replacement or removal

2. Click the” Bi-directional adjustment” to perform the Bi-directional printing alignment by following the procedure displayed on the screen.
3. When the Adjustment is completed following message is displayed.



Figure 5-44. All adjustment is completed

4. Click the “Get status” button and check the waste drain ink pad counter in this function. If the waste drain ink pad counter is around the limit counter, replace the pad and reset the counter according to the customer request.
5. Click the “Menu” button to exit this program.

5.2.6 CR motor replacement or removal

1. After you replace or remove the CR motor in the service activity, Click the “CR motor replacement or removal” in the Sequential repair service program.

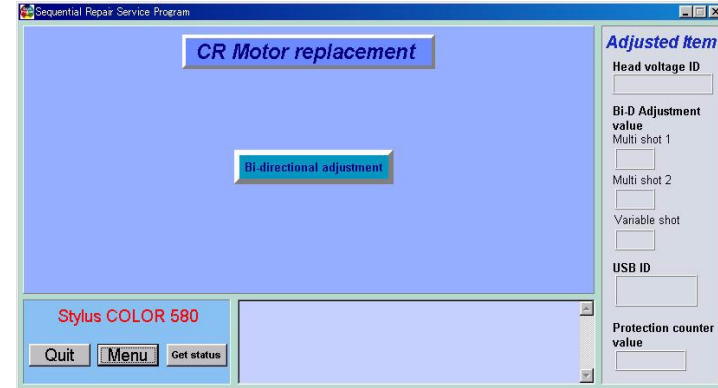

Figure 5-45. CR motor replacement or removal

2. Click the” Bi-directional adjustment” to perform the Bi-directional printing alignment by following the procedure displayed on the screen.
3. When the Adjustment is completed following message is displayed



Figure 5-46. All adjustment is completed

4. Click the “Get status” button and check the waste drain ink pad counter in this function. If the waste drain ink pad counter is around the limit counter, replace the pad and reset the counter according to the customer request.
5. Click the “Menu” button to exit this program.

5.2.7 Printer mechanism replacement

Stylus COLOR 580 dose not have ASP printer mechanism. So, you may not have a chance to use this function in your service activity. However, in case you change the printer mechanism in your printer swap service, use this function. The adjustment item and the order are same as “Printhead replacement”. So, as for the detail, refer to Section 5.2.3 on page 109.

NOTE: Use the function for the following case.
 * Printer mechanism (except the waste drain ink pad and circuit board, printhead) is changed with other one

1. Click the “Printer mechanism replacement” in the Sequential repair service program. Following menu is displayed.

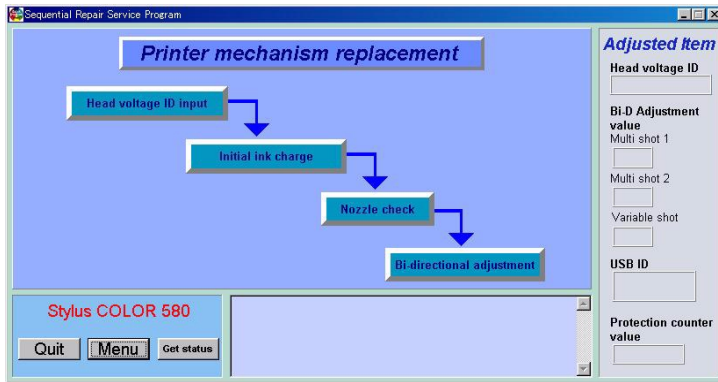

Figure 5-47. Printer mechanism replacement

2. Follow the adjustment item displayed on the above menu. For the detail, refer to Section 5.2.3 on page 109 due to the adjustment item and order are same as “Printhead replacement”.

5.2.8 Waste ink pad replacement

When the Waste drain ink pad is replaced with new one due to the maintenance error, you have to replace the Waste drain ink pad with new one and reset the counter.

1. Connect the printer to your PC and run the Adjustment program. If the waste drain ink pad counter reaches to the limit counter, the status monitor of this program displays the “Maintenance error” automatically.

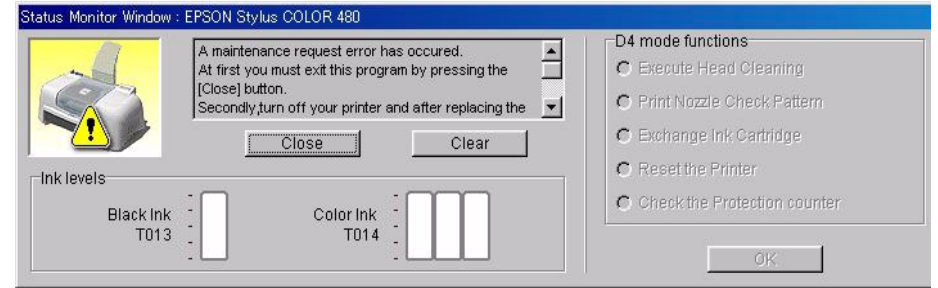

Figure 5-48. Maintenance error

2. Turn off the printer and replace the Waste drain ink pad with new one. Click the “Clear” button to clear the waste drain ink pad counter stored in the EEPROM on the Main board after turn on the printer. If the status monitor dose not detect the Waste drain ink pad counter correctly, click the “Waste ink pad replacement” in the sequential repair service program and use the following function. Clicking the “Protection counter clear” button clears the counter in the EEPROM. The suitable waste drain ink pad life is set in the EEPROM automatically according to the market setting of the initial setting menu.



Figure 5-49. Waste drain ink pad replacement

5.3 Individual service adjustment program feature

This program menu is almost same as the previous adjustment program. However, this program can run under the D4 protocol. So, followings new function is available.

- Get status function
This function can check the printer status even if the printer is error condition except the main (CPU, I/F receiver IC, RAM) logic circuit failure, and control the printer by using the D4 mode functions.
- Protection counter reset/check function (waste drain ink pad counter)
The previous adjustment program runs under the IEEE1284 Nibble protocol. So, in case the protection counter reaches to the limit counter, the protection counter reset function is not available because the printer is error condition (maintenance error). However, this function of this program can reset the counter even if the maintenance error occurs.
- EEPROM check function
You can check the EEPROM data or can write down the specific data into the EEPROM directly by using this function even if the printer is error condition. However, in case the one of the main logic circuit (CPU, I/F receiver IC, EEPROM, RAM) is broken, this function is not available.
- Refurbishment for DOA
This function charge the cleaning liquid into the printhead cavity and eject the cleaning liquid to the waste drain ink pad. By this operation, the printhead and cap assembly is cleaned. Prepare the dummy ink cartridge and S46 cleaning liquid, injector before use this program.

Depending on the situation, use the individual adjustment program. In this section, we will explain only the important item and notice about the usage of this program.

5.3.1 Get status function

This function is available in the Individual service adjustment program also. Use this function depend on the situation. However, if any error occurs on the printer while using the program, Status monitor is displayed automatically and indicates the error status for your confirmation. This function is completely same as the Get status function built in the Sequential repair service program.

5.3.2 Head cleaning function

This printhead cleaning is CL1 and about 1/8 of the brand-new black I/C and 1/18 of the brand-new color I/C are consumed. Before use this function, check the remaining ink amount of the both I/C by using the "Get status" function.

5.3.3 Initial ink charge function

This function consume about 1/2 of the brand-new black I/C and 1/7 of the brand-new color I/C. Before use this function, check the remaining ink amount of the both I/C by using the "Get status" function. So, do not use this function frequently.

5.3.4 Protection counter check/reset

This function resets or checks the current waste drain ink pad counter. Especially, use the counter check function before return the repair product to your customer. If the waste drain ink pad counter is near end condition, contact your customer and recommend your customer to replace the waste drain ink pad with new one.

5.3.5 EEPROM check function

You can check the EEPROM data or can write the specific data into the specific address of the EEPROM directly even if the printer is error condition. (In case one of the main logic circuit such as CPU, I/F receiver IC, RAM, EEPROM is broken, this function is not available)

Select the “EEPROM check” function in the Maintenance menu. The main menu of this function is as following figure. The following three function is built in this program.

- Check the cleaning counter
You can check the following information stored in the EEPROM.
* How many times of the manual cleaning were performed on the product.
* What kind of the manual cleaning was performed on the product.
- Check the EEPROM data
You can check the specific data stored in the specific address of the EEPROM.
Input the specific address with hexadecimal code by referring Section 7.1.2 on page 132 (EEPROM map). Use this function in your analysis usefully.

- Change EEPROM data
You can change the specific data stored in the specific address of the EEPROM.
However, do not use this function except the special case. Careless usage causes any trouble.

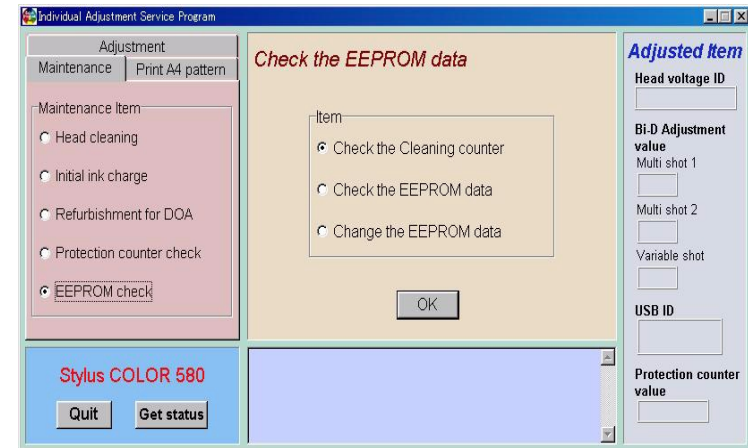

Figure 5-50. EEPROM function



- Do not use this function except the special case. Careless usage causes any trouble.

5.3.6 Refurbishment for DOA

If you clean the cavity of the printhead and cap assembly, this function will be useful.



- After carry out this function, replace the waste drain ink pad with new one and reset the Waste drain ink pad counter. Otherwise, the ink or S46 liquid may leak from the pad during the transportation.
- Prepare the following tool.
 - * Dummy ink cartridge, Injector, S46 liquid
- Do not carry out this program (Exchange sequence 1&2) repeatedly. This operation is available only one time. Excessive operation causes overflow of the ink& S46 liquid.
- When you refurbish the repair product by using this program, do it on your responsibility.
- When you charge S46 liquid into the dummy ink cartridge with the Injector, make sure fill out the dummy ink cartridge with S46 liquid. In case enough S46 liquid is not charged into the dummy cartridge, the printhead will not cleaned and not filled with the S46 liquid enough in this operation.
- Keep the S46 liquid and the dummy ink cartridge clean.

Select the “Refurbishment for DOA” function in the Maintenance menu. The main menu of this function is as following figure.

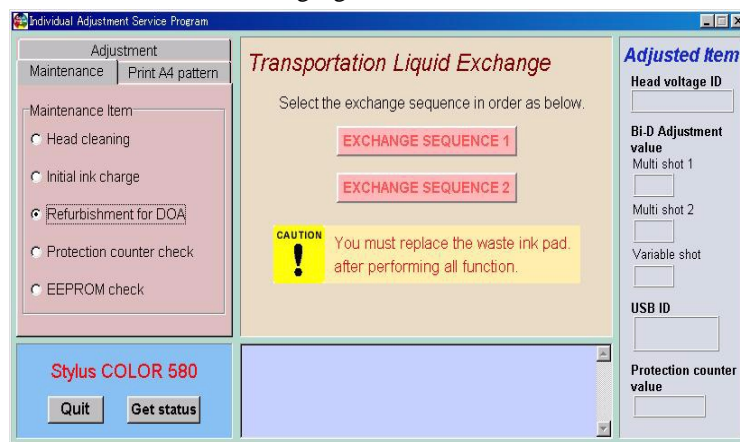

Figure 5-51. Refurbishment for DOA

- Exchange sequence 1

Set the dummy I/C filled with S46 liquid into the CR unit and click the “EXCHANGE SEQUENCE1” in the Transportation Liquid Exchange menu. The S46 liquid is charged into the printhead cavity and ink is discharged from printhead cavity to the cap.
- Exchange Sequence 2

Remove the dummy I/C from the CR unit and click the “EXCHANGE SEQUENCE2” in the Transportation Liquid Exchange menu. In this sequence, the S46 liquid is not discharged from the printhead and only the ink in the cap is discharged to the waste drain ink pad. After complete this sequence, this program set the initial ink charge flag into the EEPROM and reset the several ink consumption counters to “0”.

5.3.7 A4 Check pattern

We recommend to use this function to check the repaired product quality in your final stage of your repair. The following 6 items are printed on the check pattern.

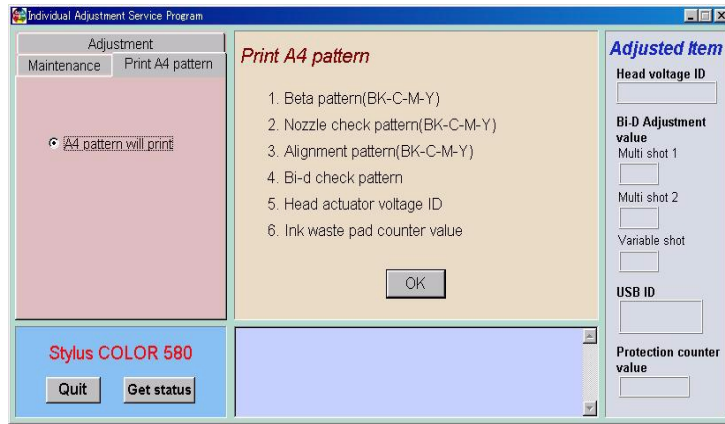

Figure 5-52. A4 Check pattern



Do not print the A4 Check pattern on the EPSON exclusive paper such as Photo quality ink jet paper. This check pattern is for the plain paper. So, use the Plain paper for this check pattern printing.



- The check point for the first black and each color solid pattern (beta pattern 360 x 360dpi normal dot) in the A4 Check pattern is as follows.
 - Any white line is not observed
 - Uneven banding is not observed extremely
- The check point for the second Nozzle check pattern (120dpi) is as follows.
 - Ink is fired from all nozzles.
 - Uneven banding is not observed extremely.
- The check point for the third Alignment pattern is as follows.
 - Each vertical line is printed straight.
- If any incorrect printing is observed on the A4 Check pattern, perform the head cleaning or bi-d adjustment. If the phenomenon is not improved, replace the printhead or suitable mechanical parts.

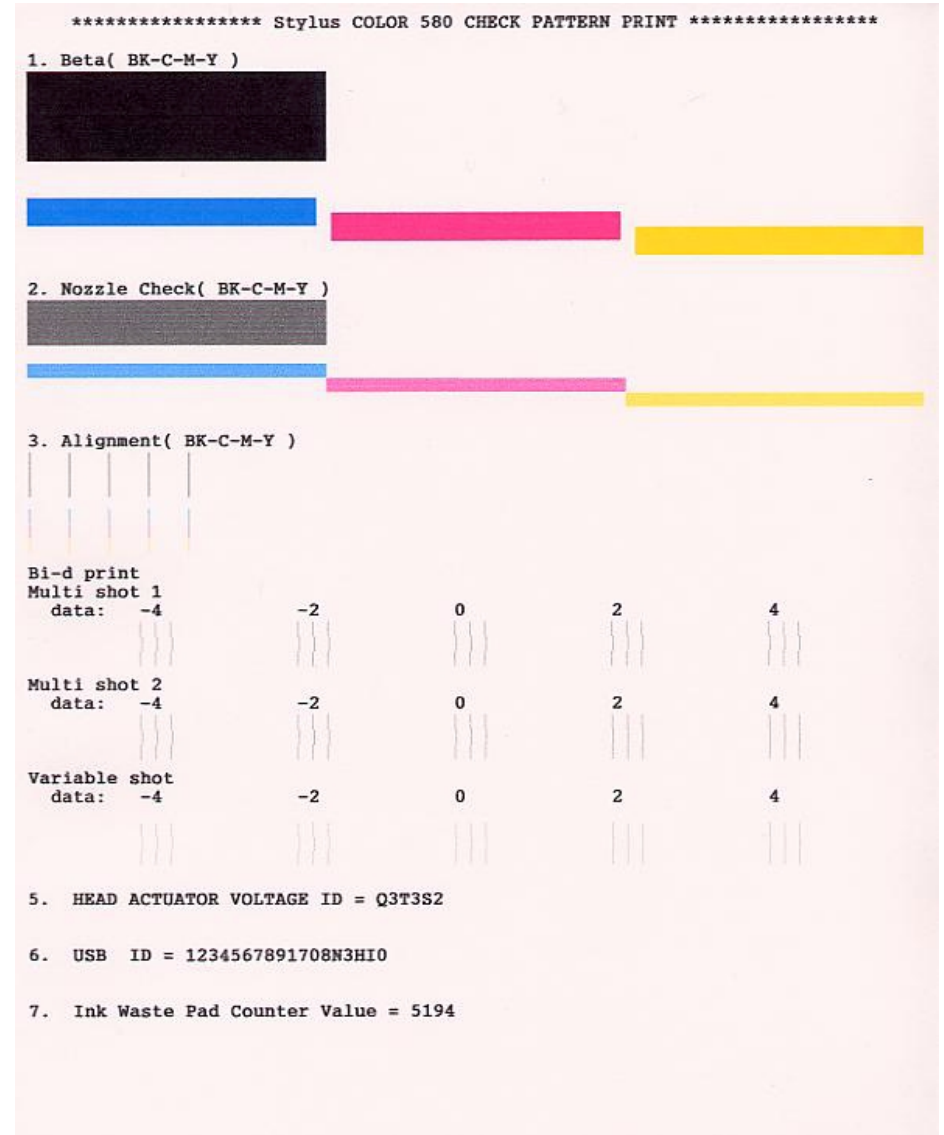

Figure 5-53. A4 Check pattern

CHAPTER

6

MAINTENANCE

6.1 Overview

This section provides information to maintain the printer in its optimum condition.

6.1.1 Cleaning

This printer has no mechanical components which require regular cleaning except the printhead. Therefore, when returning the printer to the user, check the following parts and perform appropriate cleaning if stain is noticeable.



- **Never use chemical solvents, such as thinner, benzine, and acetone to clean the exterior parts of printer like the housing. These chemicals may deform or deteriorate the components of the printer.**
- **Be careful not to damage any components when you clean inside the printer.**
- **Do not scratch the surface (coated part) of PF roller assembly. Use soft brush to wipe off any dusts. Use a soft cloth moistened with alcohol to remove the ink stain.**
- **Do not use cleaning sheet included in the media for normal usage. It may damage the coated surface of PF roller. If the adhesive surface of the cleaning sheet is set to the ASF LD roller side and used to clean the ASF LD roller surface, it is no problem.**

- Exterior parts
Use a clean soft cloth moistened with water and wipe off any dirt. If the exterior parts are stained with ink, use a cloth moistened with neutral detergent to wipe it off.
- Inside the printer
Use a vacuum cleaner to remove any paper dust.
- ASF LD Roller
If paper dust on the surface of ASF LD Roller lowers the friction, set the adhesive surface of the cleaning sheet included in the media to the surface of the ASF roller and repeat loading paper from the ASF.

6.1.2 Service Maintenance

If any abnormal print (dot missing, white line, etc.) has occurred or the Status monitor indicates Maintenance Request Error (This error is displayed as “unknown error” in the STM3), take the following actions to clear the error.

□ Head Cleaning

When dot missing or banding phenomenon has occurred, printhead cleaning operation is required by using the built-in head cleaning function. This function can be executed only from the Printer driver utility and Service Adjustment program because this printer does not have any control panel.

Stylus COLOR 580 has 3 modes for manual cleaning and even during printing, appropriate cleaning mode is automatically selected and executed according to various conditions. When you select and execute manual cleaning in the Printer driver utility, the most appropriate cleaning mode is selected and therefore the cleaning completion period varies depending on the mode. (Refer to “Ink Sequence” on page 40.)

The following is the process to perform the head cleaning from the Printer driver utility. As for the operation of the Adjustment program, refer to Chapter 5 Adjustment.

1. Make sure that the printer is in stand-by state by using the Status monitor 3. If the printer is in standby mode, following figure is indicated on the monitor.

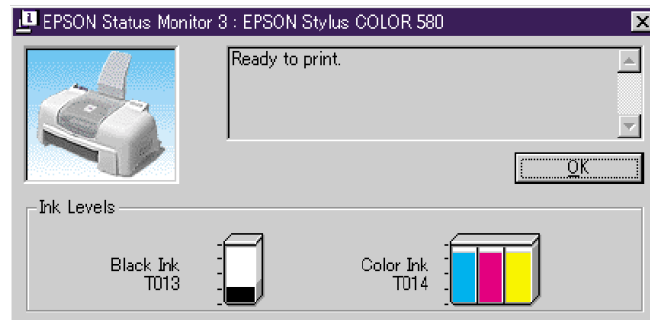

Figure 6-1. Status monitor 3 indication

2. Select the Head Cleaning in the Printer driver utility and perform the Head cleaning. After performing the head cleaning sequence, perform the print check. If you repeat cleaning without print check, the weakest cleaning, CL1 will be repeated.

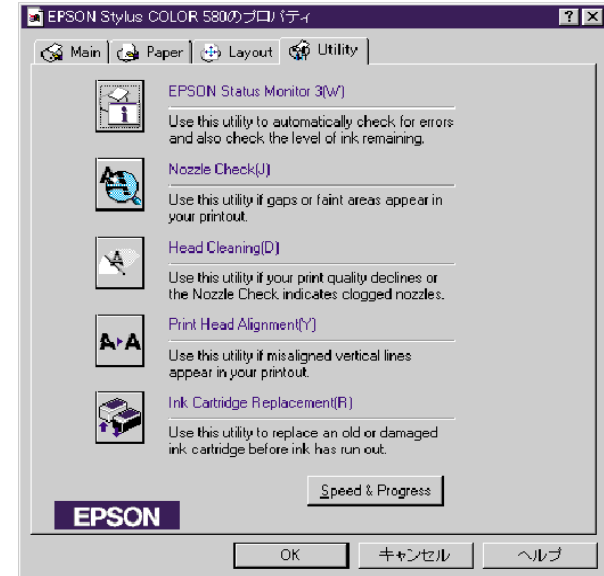

Figure 6-2. Head cleaning function in the Printer driver utility

❑ **Maintenance Request Error (Unknown error)**

Ink is used for cleaning operation as well as printing. When ink is used for cleaning, the ink is drained to Waste Ink Pad (Ink Absorber Tray Assembly) and the amount of waste ink is recorded in the EEPROM on the MAIN board. Due to this, when the waste ink has reached the limit of the absorbing capability of the Waste Ink Pad, Unknown Error is indicated on Status monitor 3 as following figure.

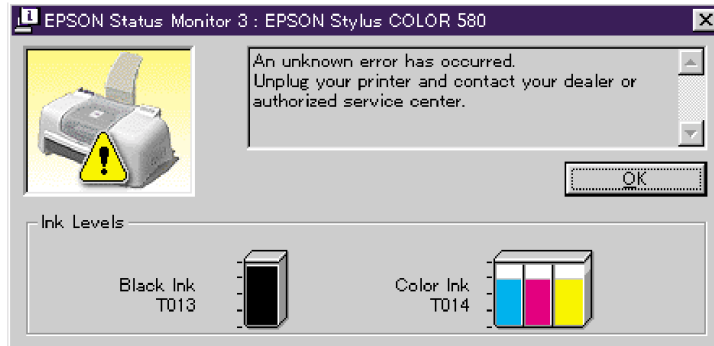

Figure 6-3. Maintenance Error indication in STM3

In this case, replace the Waste Ink Pad and clear the Waste Ink Counter stored in EEPROM. Waste Ink Counter can be reset only from the Adjustment program because this printer does not have a control panel. As for the procedure, refer to Chapter 5 Adjustment.

6.1.3 Lubrication

The characteristics of the grease have great effects on the mechanical function and durability, especially does the characteristics about temperature environment. The type and amount of grease used to lubricate the printer parts are determined based on the results of internal evaluations. Therefore, be sure to apply the specified type and amount of grease to the specified part of the printer mechanism during servicing.



- **Never use oil or grease other than those specified in this manual. Use of different types of oil or grease may damage the component or give bad influence on the printer function.**
- **Never apply larger amount of grease than specified in this manual.**

Table 6-1. Specified Lubricants

Type	Name	EPSON Code	Supplier
Grease	G-26	B702600001	EPSON
Grease	G55	1055459	EPSON

Table 6-2. Lubrication Point

No.	Lubrication Type/Point	Remarks
1	<p><Lubrication Point></p> <ul style="list-style-type: none"> Inside the CR shaft hole of the CR unit. Refer to Figure 6-4, "Lubrication point 1". <p><Lubrication Type></p> <ul style="list-style-type: none"> G-55 <p><Lubrication Amount></p> <ul style="list-style-type: none"> Whole inside the CR shaft hole evenly. 40+/15mg x 2 	<ul style="list-style-type: none"> Do not attach the grease to other portion of the CR unit. Use a syringe to apply it. Move the CR guide left and right, smooth out the Geese on the surface of the CR guide shaft. After lubrication, make sure that the carriage moves smoothly.
2	<p><Lubrication Point></p> <ul style="list-style-type: none"> Contact point between PF roller and the PF grounding spring. Refer to Figure 6-5, "Lubrication point 2". <p><Lubrication Type></p> <ul style="list-style-type: none"> G-26 <p><Lubrication Point></p> <ul style="list-style-type: none"> Φ1mm x 5mm 	<ul style="list-style-type: none"> Do not attach the grease to the paper path. Use a syringe to apply it.
3	<p><Lubrication Point></p> <ul style="list-style-type: none"> Shaft of the Pully driven shaft. Refer to Figure 6-6, "Lubrication point 3". <p><Lubrication Type></p> <ul style="list-style-type: none"> G-26 <p><Lubrication Amount></p> <ul style="list-style-type: none"> Φ1mm x 1mm 	<ul style="list-style-type: none"> Use a syringe to apply it.
4	<p><Lubrication Point></p> <ul style="list-style-type: none"> Inside the sliding slot for ASF Hopper on the ASF Frame. Refer to Figure 6-7, "Lubrication point 4". <p><Lubrication Type></p> <ul style="list-style-type: none"> G-26 <p><Lubrication Amount></p> <ul style="list-style-type: none"> Φ1mm x 4points 	<ul style="list-style-type: none"> Use a syringe to apply it. After lubrication, move the ASF hopper manually and smooth out the grease inside the ASF frame.

Table 6-2. Lubrication Point

No.	Lubrication Type/Point	Remarks
5	<p><Lubrication Point></p> <ul style="list-style-type: none"> Specified both edges area on the Front frame. Refer to Figure 6-8, "Lubrication point 5". <p><Lubrication Type></p> <ul style="list-style-type: none"> G-26 <p><Lubrication Amount></p> <ul style="list-style-type: none"> Φ1mm x 40mm x 2 areas 	<ul style="list-style-type: none"> Use a syringe to apply it. After lubrication, move the CR unit left or right and smooth out the grease on the Front frame.
6	<p><Lubrication Point></p> <ul style="list-style-type: none"> Between the Cam parts on the LD roller shaft and the ASF Hopper. Refer to Figure 6-9, "Lubrication point 6". <p><Lubrication Type></p> <ul style="list-style-type: none"> G-26 <p><Lubrication Amount></p> <ul style="list-style-type: none"> Φ1mm x 1mm 	<ul style="list-style-type: none"> The Cam parts on the LD roller shaft must touch the G-26 lubricated on the ASF hopper in the LD roller shaft rotation.
7	<p><Lubrication Point></p> <ul style="list-style-type: none"> Surface of the shaft on the Spur gear 15, EJ at the Pump unit side. Refer to Figure 6-10, "Lubrication point 7". <p><Lubrication Type></p> <ul style="list-style-type: none"> G-26 <p><Lubrication Amount></p> <ul style="list-style-type: none"> Φ1mm x 1mm 	

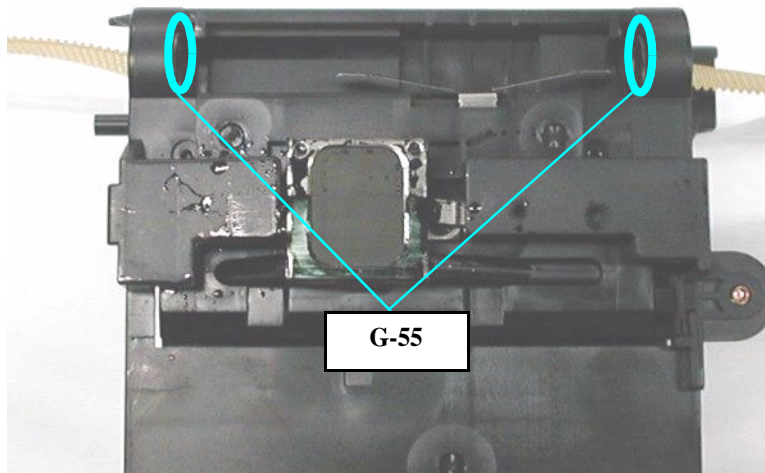

Figure 6-4. Lubrication point 1

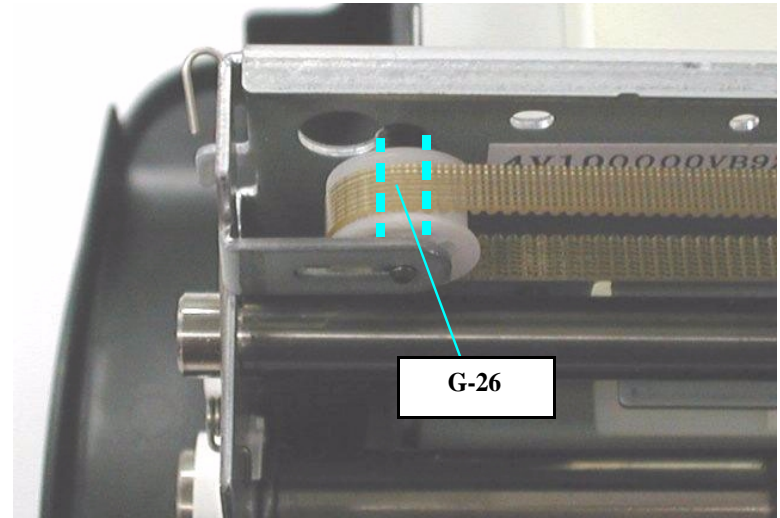

Figure 6-6. Lubrication point 3

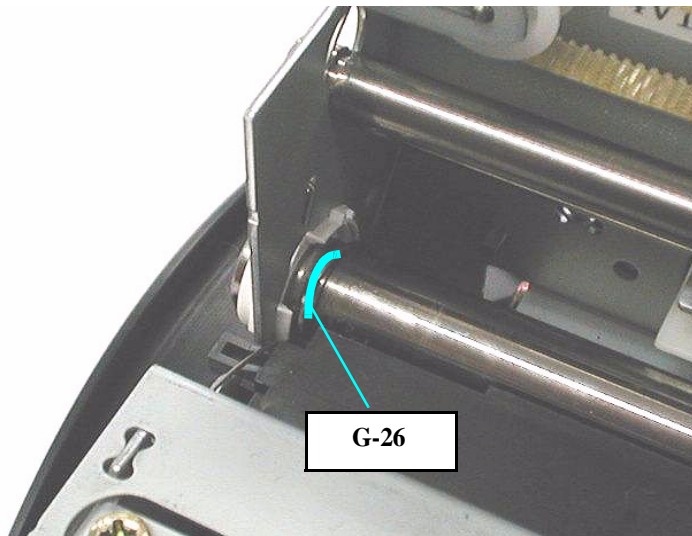

Figure 6-5. Lubrication point 2

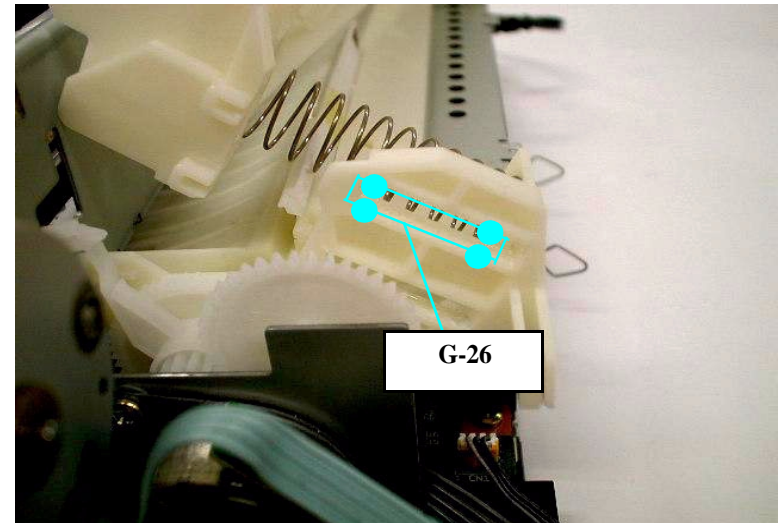

Figure 6-7. Lubrication point 4

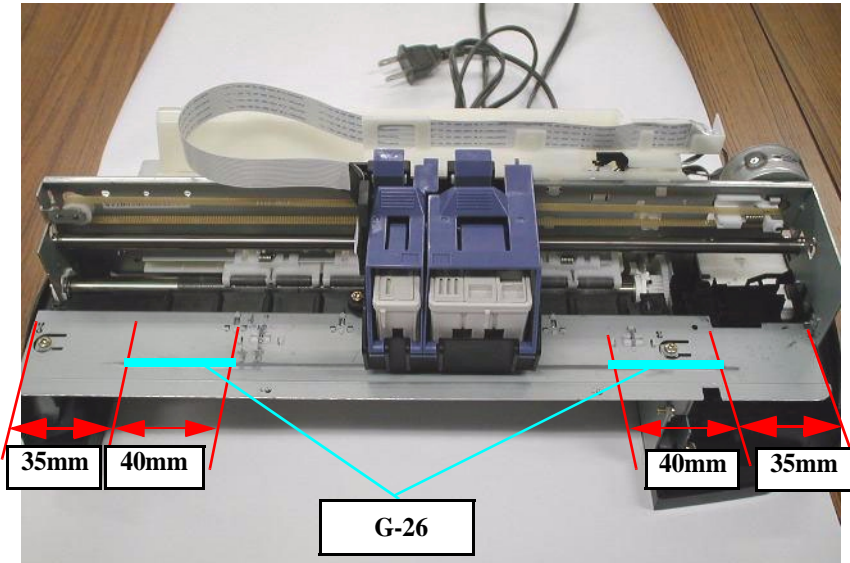

Figure 6-8. Lubrication point 5

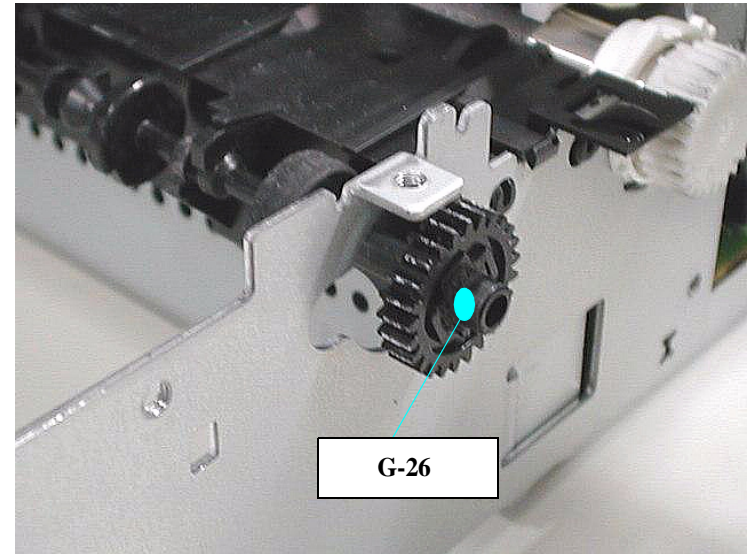

Figure 6-10. Lubrication point 7

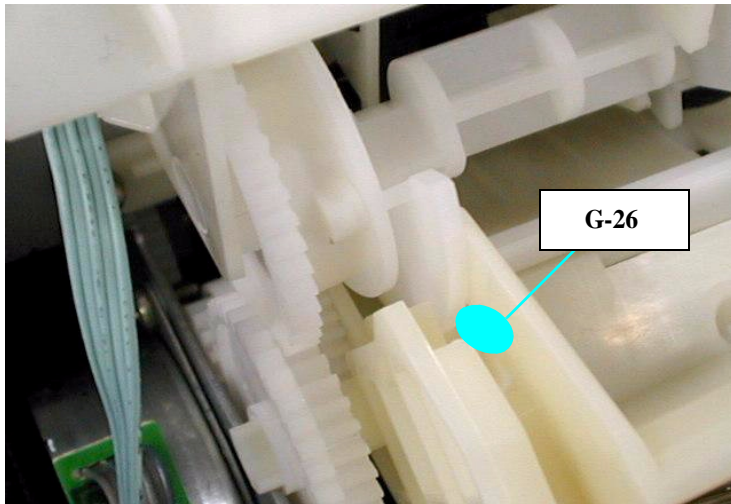

Figure 6-9. Lubrication point 6

CHAPTER

7

APPENDIX

7.1 Connector Summary

7.1.1 Major Component Unit

The Major component units of this printer are as follows.

- Main Board (C379MAIN-B or C379MAIN-C)
- Power Supply Board (C367PSB/PSE)

The figure below shows how these components connect.

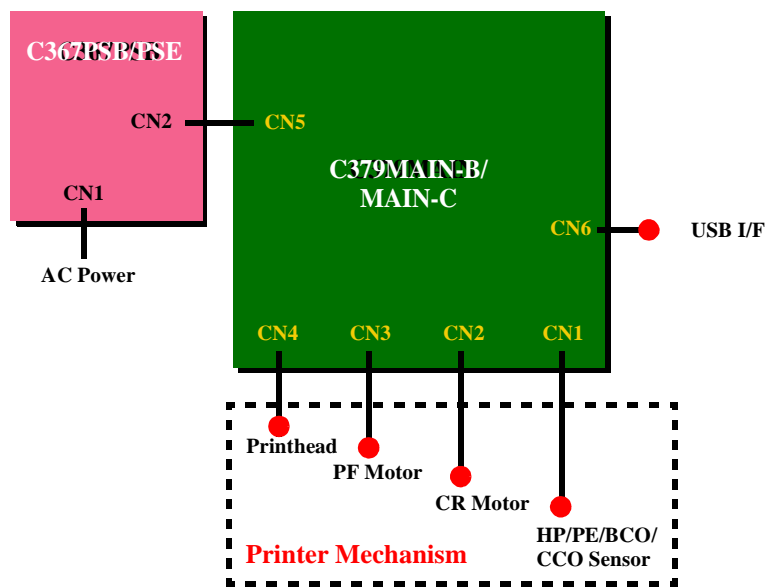

Figure 7-1. Connection of the Major Components

See the following tables for the connector summary for the C379MAIN board and each connector's pin alignment.

Table 7-1. Connector Summary for C379MAIN/MAIN-B

Connector	Function	Table to refer to
CN1	For connection with the HP/PE/BCO/CCO sensor	Table 7-2
CN2	For connection with the CR motor	Table 7-3
CN3	For connection with the PF motor	Table 7-4
CN4	For connection with the printhead	Table 7-5
CN5	For connection with the power supply board	Table 7-6
CN6	For connection with the USB interface	Refer to "USB Interface" on page 21

Table 7-2. CN1 - HP/PE/BCO/CCO Sensor

Pin	Signal Name	I/O	Function
1	HPPE	In	Sensor detect signal
2	GND	---	Ground
3	HPPEV	---	Sensor Power Supply

Table 7-3. CN2 - CR Motor

Pin	Signal Name	I/O	Function
1	CRA	Out	Phase drive signal (A)
2	CRB	Out	Phase drive signal (-A)
3	CR-A	Out	Phase drive signal (B)
4	CR-B	Out	Phase drive signal (-B)

Table 7-4. CN3 - PF Motor

Pin	Signal Name	I/O	Function
1	PFA	Out	Phase drive signal (A)
2	PFB	Out	Phase drive signal (-A)
3	PF-A	Out	Phase drive signal (B)
4	PF-B	Out	Phase drive signal (-B)

Table 7-5. CN4 - Printhead

Pin	Signal Name	I/O	Function
1	THM	In	Thermistor detect signal
2	CH	Out	Waveform selection signal for MS shot & variable shot
3	GND	---	Ground
4	LAT	Out	Head data latch pulse output
5	GND	---	Ground
6	NCHG	Out	All nozzle fire selection pulse
7	GND	---	Ground
8	SCK	Out	Serial clock
9	GND	---	Ground
10	SI2	Out	Print data output (2)
11	SP	Out	Select signal for CH signal
12	SI1	Out	Print data output (1)
13	VDD	---	Logic power supply (+5V)
14	GND2	---	Ground
15	COM	---	Head drive pulse (trapezoid waveform)
16	VHV	---	+42V power supply for nozzle selector

Table 7-6. CN5 - Power Supply Board

Pin	Signal Name	I/O	Function
1	+42V	---	Mechanism drive power supply
2	+42V	---	Mechanism drive power supply
3	GND	---	Ground
4	GND	In	Energy saving signal
5	NC	In	Not connected
6	GND	---	Ground
7	GND	---	Ground
8	+5V	---	Logic power supply

7.1.2 EEPROM Address Map

Table 7-7. EEPROM Address Map

Address	Explanation	Setting	QPIT setting	Factory setting
00H	Password 0		5AH	5AH
01H			0FH	0FH
02H	Market	0: World 1: Japan 2: Custom (MJ-)*2 3: Custom (Stylus COLOR)*2 4: Custom (other name)*2	00H	00H
03H	1st dot adjustment	$-40 \leq n \leq 40$ (by 1/1440 inch)	00H	(*1)
04H	Bi-D adjustment data (Multi shot 2)	$-36 \leq n \leq 36$ (by 1/1440 inch)	00H	(*1)
05H	Bi-D adjustment data (Multi shot 1)	$-36 \leq n \leq 36$ (by 1/1440 inch)	00H	(*1)
06H	Uni-D adjustment data	$-36 \leq n \leq 36$ (by 1/1440 inch)	00H	(*1)
07H	Bi-D adjustment data (Variable shot)	$-36 \leq n \leq 36$ (by 1/1440 inch)	00H	(*1)
08H	Carriage speed adjustment data	$-4 \leq n \leq 4$ (by G.A. timer unit)	00H	00H
09H	Head actuator rank ID for VhL		00H	(*1)
0AH	Head actuator rank ID for VhN		00H	(*1)
0BH	Head actuator rank ID for VhM		00H	(*1)
0CH	Head actuator rank ID for VhV		00H	(*1)
0DH	Head actuator rank ID for AR		00H	(*1)

Table 7-7. EEPROM Address Map (continued)

Address	Explanation	Setting	QPIT setting	Factory setting
0EH	Head rank MW-ID		00H	00H
0FH	Reserved		00H	00H
10H	Password 1		5AH	5AH
11H			0FH	0FH
12H	Head actuator rank ID for IWAB		00H	00H
13H	Head actuator rank ID for IWCD		00H	00H
14H	Head actuator rank ID for IWEF		00H	00H
15H	Reserved		00H	00H
16H-19H	Custom EEPROM sub number		00H	00H
1AH-1DH	Reserved		00H	00H
1EH	Reserved		00H	00H
1FH-21H	Reserved		00H	00H
22H	Interface selection	0: Auto 1: Parallel (Reserved) 2: Serial (Reserved) 3: USB	00H	00H
23H	Interface wait time	0 to 255 (by second)	0AH	0AH
24H	Parallel I/F speed (Reserved)	0: High speed 1: Normal	00H	00H
25H	IEEE1284.4 for Parallel (Reserved)	0: Auto 1: On 2: Off	00H	00H
26H	IEEE1284.4 for USB	0: Auto 1: On 2: Off	00H	01H

Table 7-7. EEPROM Address Map (continued)

Address	Explanation	Setting	QPIT setting	Factory setting
27H	Print direction control	0: Bi-D 1: Uni-D 2: Auto	02H	02H
28H	Reserved		00H	00H
29H	Bi-d Alignment request	bit2 :Bi-d Alignment request (0=request, 1=no request)	00H	00H
2AH	Reserved for CG table		00H	00H
2BH-2FH	Printer-ID String for USB		00H	00H
30H-39H			00H	00H
3AH-3DH			00H	00H
3EH	CR-phase of Home		00H	00H
3FH	reserved		00H	00H
40H	Password 3		5AH	5AH
41H			0FH	0FH
42H	Ink flags	bit7: reserved bit6: black "one time" bit5: color "one time" bit4: Initial fill required bit3: reserved bit2: in cleaning seq. bit1: black CL required bit0: color CL required	00H	10H

Table 7-7. EEPROM Address Map (continued)

Address	Explanation	Setting	QPIT setting	Factory setting
43H	Ink flags 2	bit5: Printed after Cleaning 0: Not printed after Cleaning 1: Printed after Cleaning bit4: YMC first cartridge 0: Not first cartridge 1: first cartridge bit3: Black first cartridge 0: Not first cartridge 1: first cartridge bit2: YMC cartridge changed and cleaned 0: first cartridge 1: changed bit1: Black cartridge changed and cleaned 0: first cartridge 1: changed bit0: Black cartridge changed and cleaned 0: with YMC cartridge 1: alone	00H	00H
44H-47H	Ink counter Cb (total) 1 count = 100 (ng)		00H	00H
48H-4BH	Ink counter Cy (total) 1 count = 100 (ng)		00H	00H
4CH-4FH	Ink counter Cm (total) 1 count = 100 (ng)		00H	00H
50H	Password 4		5AH	5AH
51H			0FH	0FH
52H-55H	Ink counter Cc (total) 1 count = 100 (ng)		00H	00H

Table 7-7. EEPROM Address Map (continued)

Address	Explanation	Setting	QPIT setting	Factory setting
56H	Cleaning counter for CL1 counter		00H	00H
57H	Cleaning counter for CL1' counter		00H	00H
58H	Cleaning counter for CL2 counter		00H	00H
59H	Cleaning counter for out of HP CL counter		00H	00H
5AH	Cleaning counter for timer cleaning counter		00H	00H
5BH	Cleaning counter for Bk replace CL counter		00H	00H
5CH	Cleaning counter for YMC replace CL counter		00H	00H
5DH	Reserved		00H	00H
5EH	Reserved		00H	00H
5FH	Reserved		00H	00H
60H	Password 5		5AH	5AH
61H			0FH	0FH
62H	Ink counter Rb0		00H	00H
63H			00H	00H
64H	Ink counter Ry0		00H	00H
65H			00H	00H
66H	Ink counter A		00H	(*3)
67H			00H	(*3)

Table 7-7. EEPROM Address Map (continued)

Address	Explanation	Setting	QPIT setting	Factory setting
68H	Reserved		00H	00H
69H	Reserved		00H	00H
6AH	CL time	Time data command which is sent from printer driver is stored only when the Timer CL is performed.	00H	00H
6BH			00H	00H
6CH	accumulated printing time	0: minute 1: 15 minutes 2: 30 minutes 3: 60 minutes 4: 90 minutes 5: 120 minutes	00H	00H
6DH			00H	00H
6EH	CL Time without timer command	Time data which is generated in the CPU clock is stored.	00H	00H
6FH			00H	00H
70H	Reserved for Password 7		00H	00H
71H			00H	00H
72H-79H 7AH-7FH	customized model name	string of model field for Device ID	00H	00H

- *1 Adjusted at factory.
- *2 01H is factory setting for customizes.
- *3 66H and 67H are factory setting for Market specification.

Table 7-8.

Market	EEPROM address	EEPROM setting
Total print volumes 10000 pages	66H	88H
	67H	13H
Total print volumes 20000 pages	66H	00H
	67H	00H

7.2 Component Layout

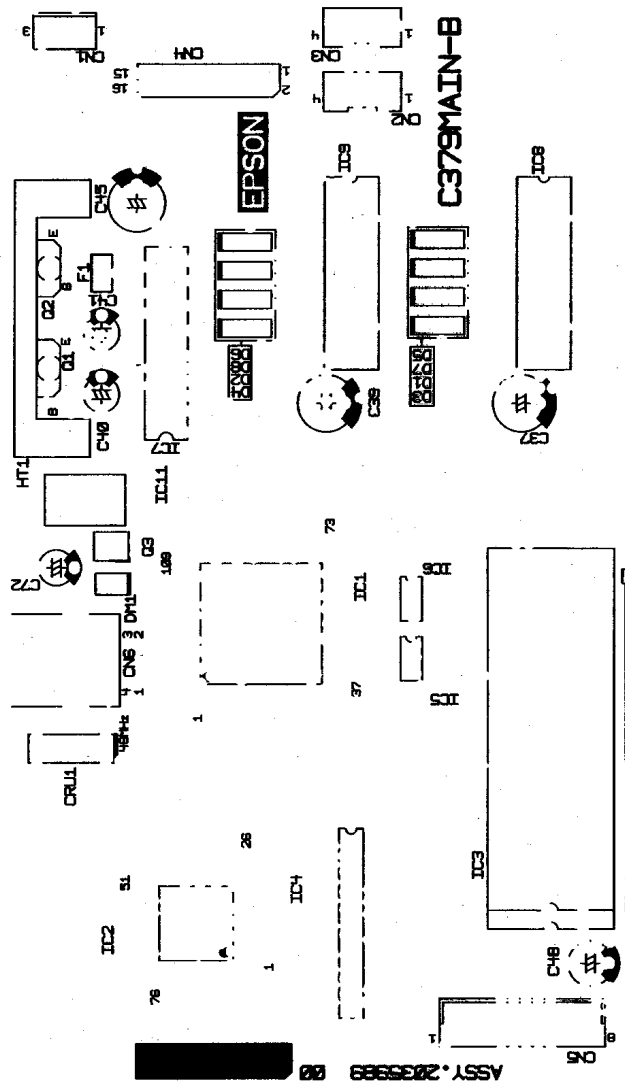

Figure 7-2. C379MAIN-B Component Layout (Parts Side)

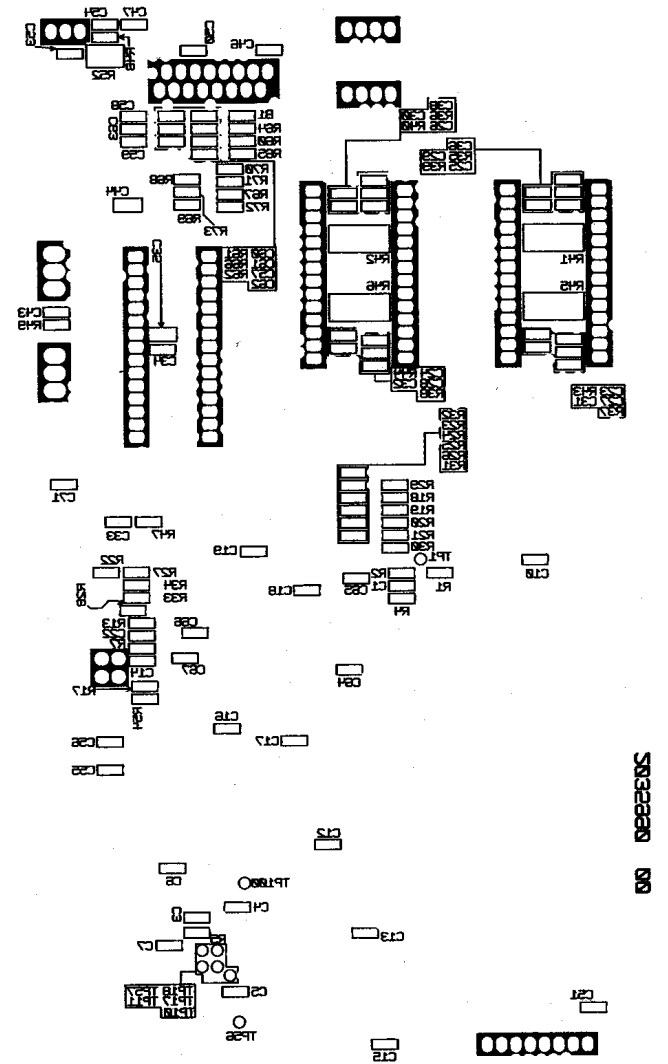

Figure 7-3. C379MAIN-B Component Layout (Soldered side)

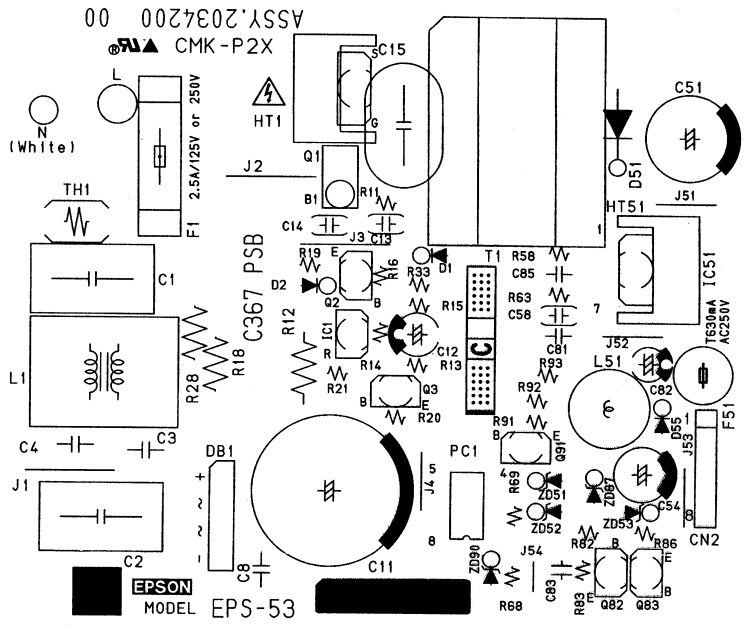

Figure 7-4. C367PSB Component Layout

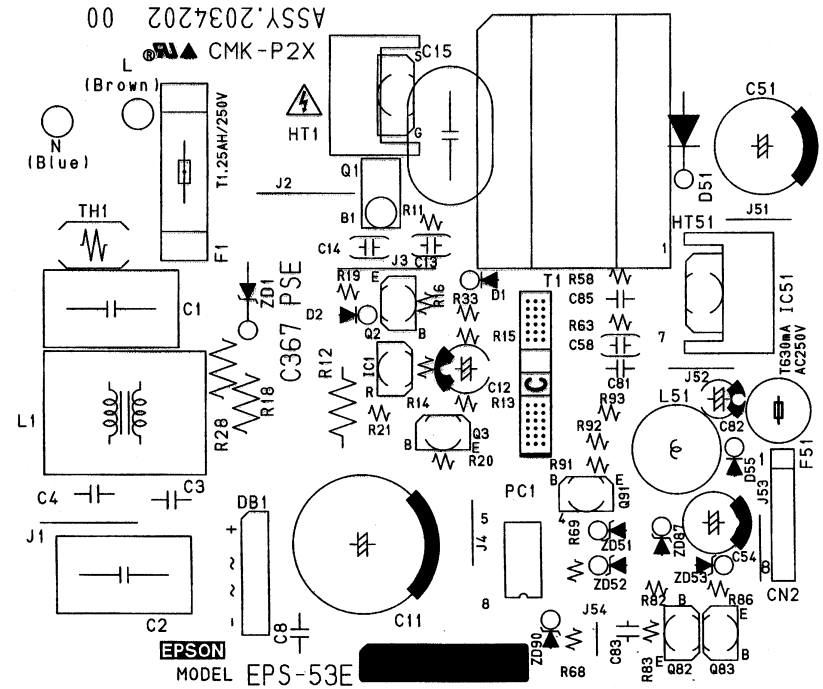

Figure 7-5. C367PSE Component Layout

7.3 Exploded Diagram

Following pages shows exploded diagram.

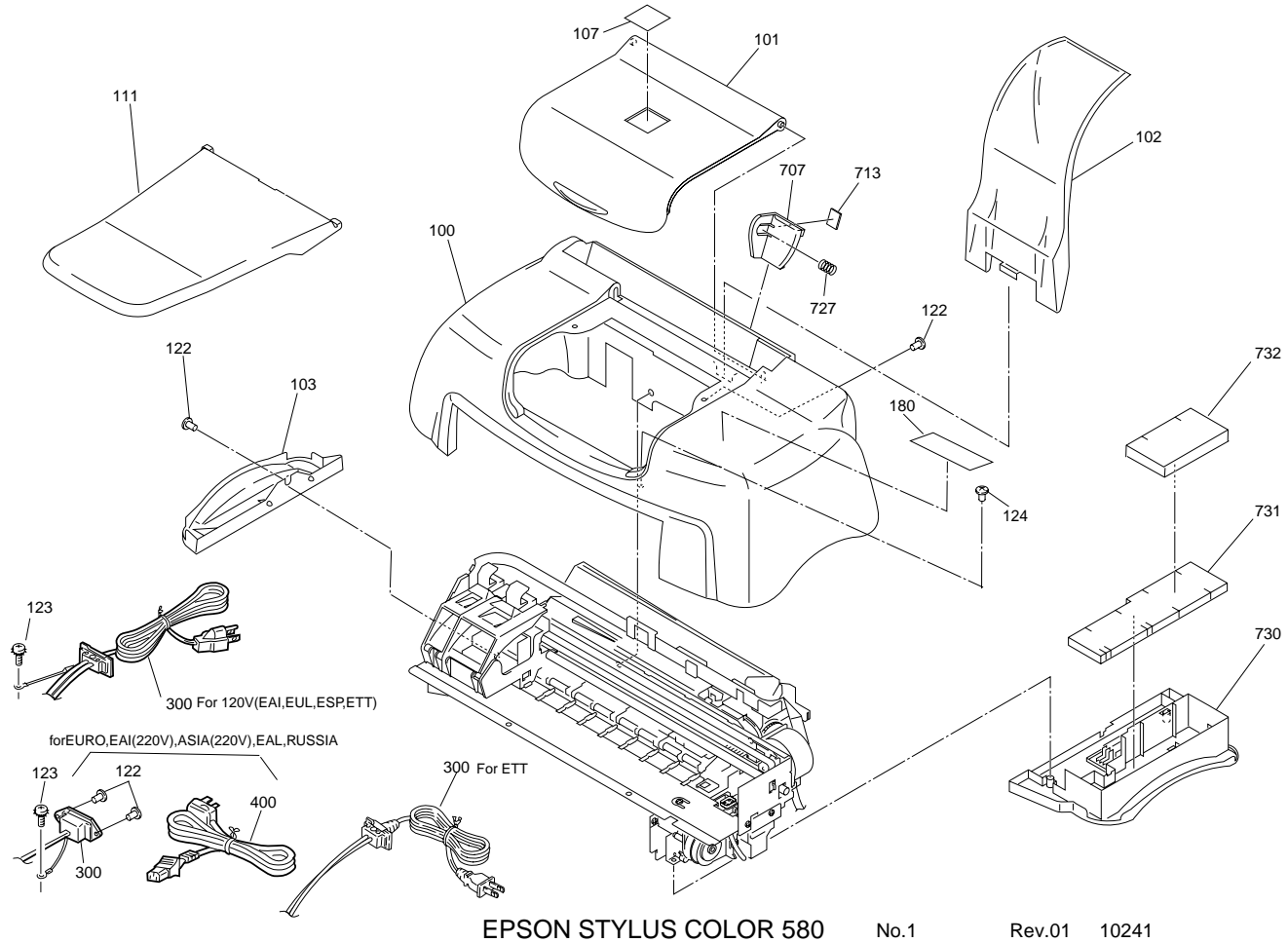
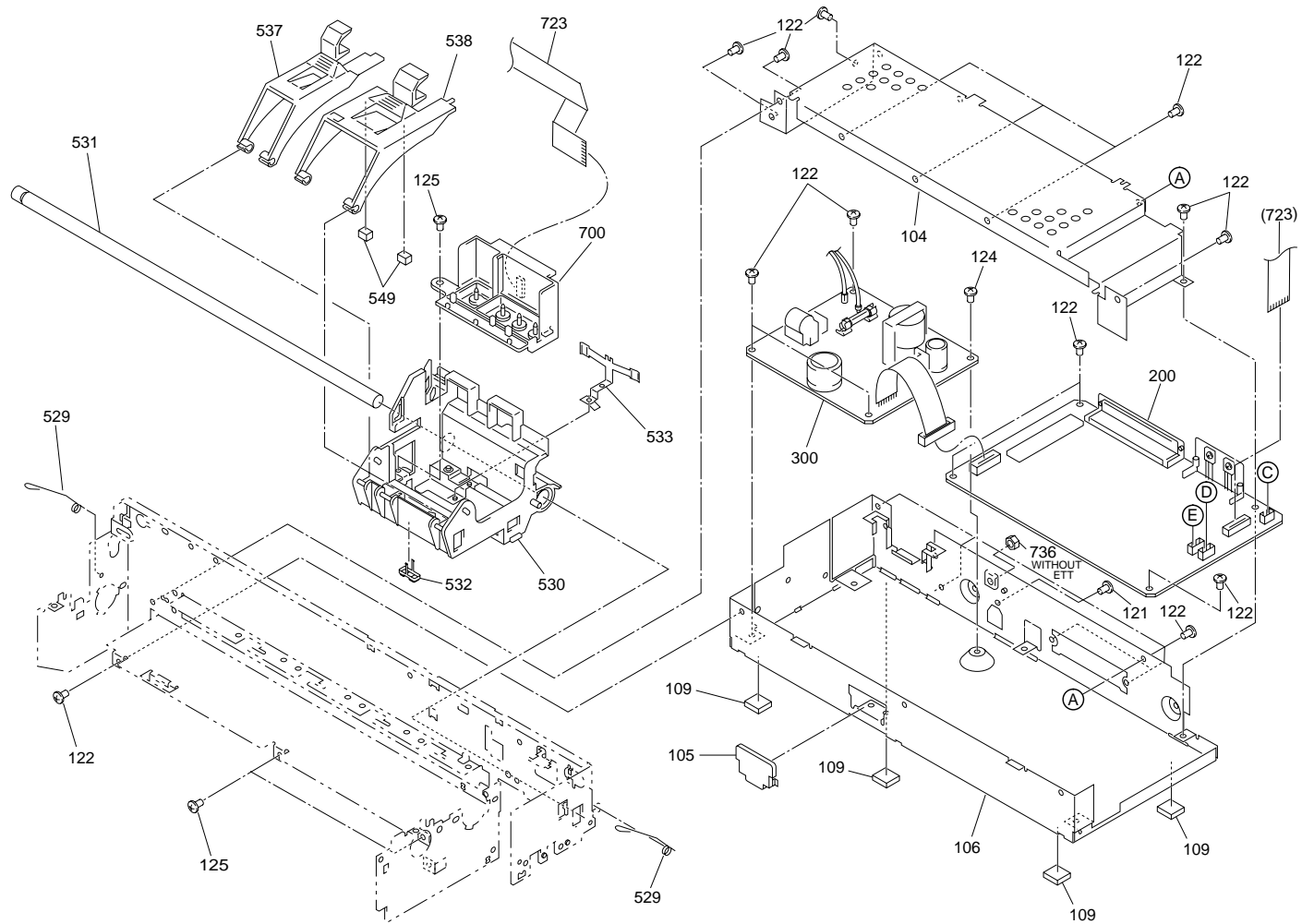
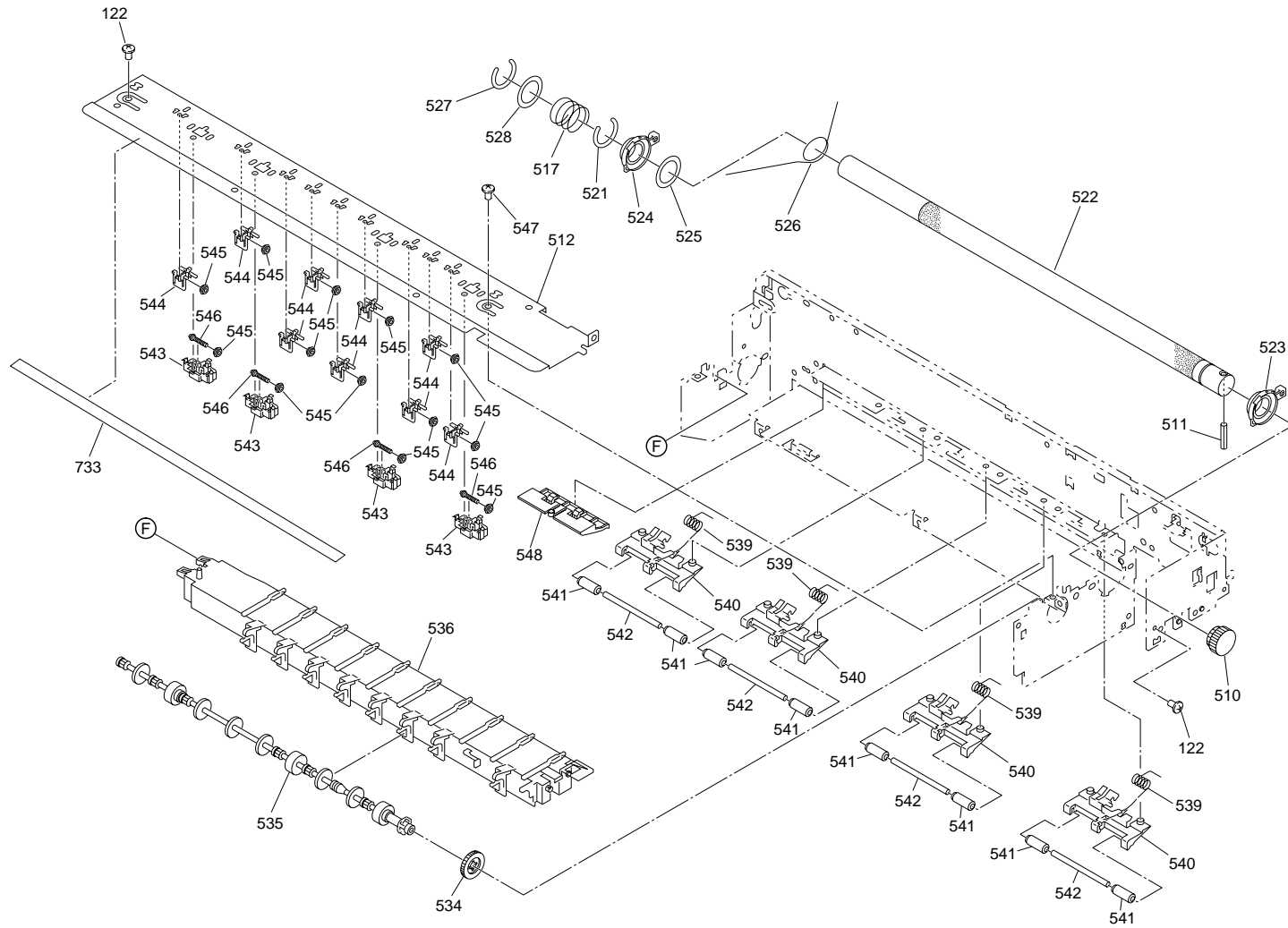

Figure 7-6. Stylus Color 580 Exploded Diagram 1



EPSON STYLUS COLOR 580 No.2 Rev.01 10241

Figure 7-7. Stylus Color 580 Exploded Diagram 2



EPSON STYLUS COLOR 580 No.3 Rev.01 10241

Figure 7-8. Stylus Color 580 Exploded Diagram 3

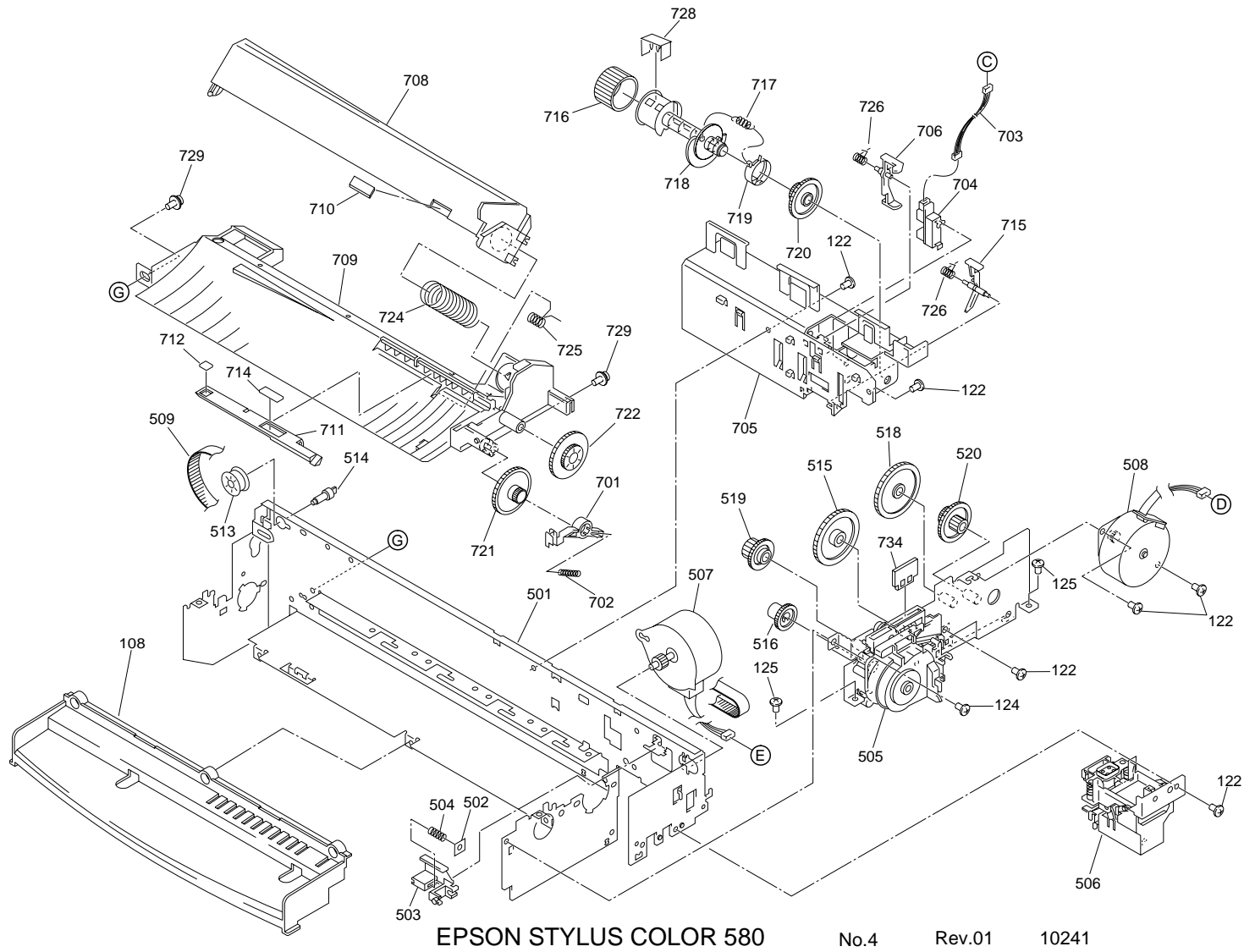

Figure 7-9. Stylus Color 580 Exploded Diagram 4

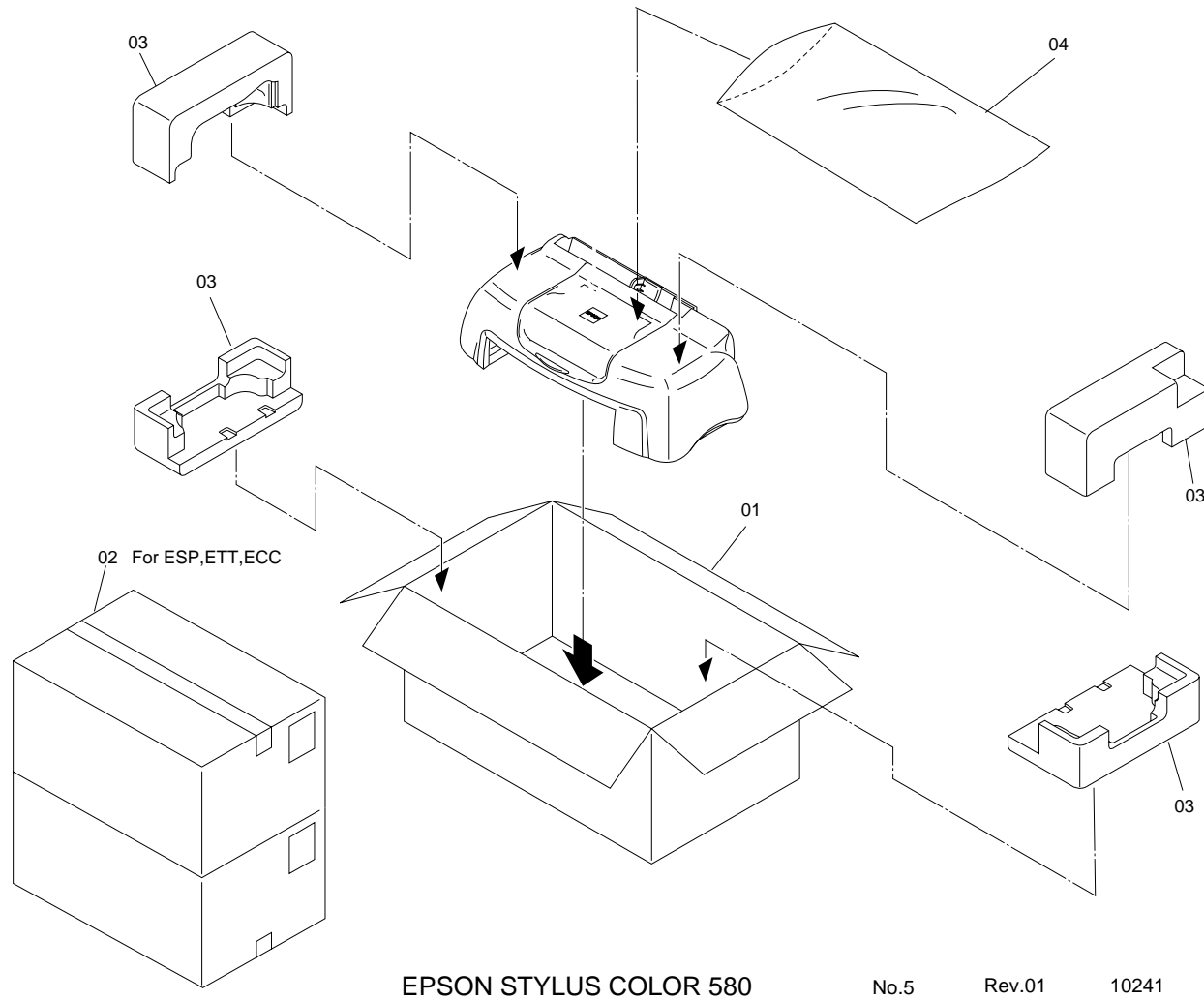

Figure 7-10. Stylus Color 580 Packing material

7.4 Parts List

Table 7-9. Stylus COLOR 580 Parts List

Ref No.	Description
100	HOUSING
101	COVER,PRINTER;B
102	PAPER SUPPORT;C
103	HOUSING,SUPPORT,LEFT
104	SHIELDPLATE,UPPER
105	COVER,SHIELD PLATE,LEFT
106	SHIELD PLATE,M/B
107	LOGO PLATE 27.5X27.5
108	HOUSING,FRONT
109	FOOT
111	STACKER
121	C.P.SCREW
122	C.B.S. SCREW
123	C.B.(O) SCREW,4X5,F/ZG
124	C,B,S-TITE R.SCREW,3X6,F/UC
125	C.B.P-TITE SCREW,3X8,F/ZN
180	LABEL,MODEL NAME
D5	DIODE
Q1	TRANSISTOR
200	BOARD ASSY., MAIN
B1	BEADS CORE
CN1	CONNECTOR
CN2	CONNECTOR

Table 7-9. Stylus COLOR 580 Parts List

Ref No.	Description
CN3	CONNECTOR
CN4	CONNECTOR
CN6	CONNECTOR
CRU1	QUARTZ OSCILLATOR
D1	DIODE
D2	DIODE
D3	DIODE
D4	DIODE
D6	DIODE
D7	DIODE
D8	DIODE
DM1	DIODE ARRAY
F1	FUSE
HT1	HEAT SINK
IC1	ASIC,E05B88NA
IC11	3-TERMINAL REGULATOR
IC2	MICRO CONTROLLER,TMP95C061BF
IC3	IC SOCKET
IC4	DRAM
IC6	RESET IC
IC7	IC
IC8	HIC
IC9	HIC
Q2	TRANSISTOR
Q3	TRANSISTOR

Table 7-9. Stylus COLOR 580 Parts List

Ref No.	Description
300	BOARD ASSY.,POWER SUPPLY
501	FRAME,MAIN
502	REINFORCEMENT PLATE,HOLDER
503	HOLDER,MOTOR ASSY.,CR
504	COMPRESSIONSPRING,15.7
505	PUMP ASSY.
506	CAP ASSY.
507	MOTOR ASSY.,CR
508	MOTER ASSY.,PF
509	TIMINGBELT
510	SPUR GEAR,15
511	SPRINGPIN,2X14.5
512	FRAME,FRONT
513	PULLEY,DRIVEN
514	SHAFT,PULLEY,DRIVEN
515	SPUR GEAR,34.2
516	COMBINATION GEAR,12.6,18.4
517	COMPRESSION SPRING,5.85
518	SPURGEAR,15.2
519	COMBINATION GEAR,8.4,21.6
520	COMBINATION GEAR,9.6,33.6
521	SPACER,C-RING
522	ROLLER,PF
523	BUSHING,ROLLER,PF
524	BUSHING,ROLLER,PF,LEFT

Table 7-9. Stylus COLOR 580 Parts List

Ref No.	Description
525	SPACER,FASTEN,ROLLER,PF
526	GROUNDING WIRE,ROLLER,PF
527	C-RING
528	PLANE WASHER,12.2X0.5X15
529	RODSPRING,SHAFT,CR,GUIDE
530	CARRIAGE;B
531	SHAFT,CR,GUIDE
532	SLIDER,CR
533	GROUNDINGPLATE,HEAD
534	SPUR GEAR,15,EJ
535	ROLLER,EJECT
536	PAPERGUIDE,ERONT
537	COVER,CARTRIDGE,BK;B
538	COVER,CARTRIDGE,C;B
539	TORSION SPRING,52.92
540	PAPERGUIDE,UPPER
541	ROLLER,DRIVEN
542	SHAFT,ROLLER,DRIVEN
543	HOLDER,STARWHEEL,FRONT
544	HOLDER,STARWHEEL,REAR
545	STARWHEEL ASSY.,8;E
546	ROD SPRING,STAR WHEEL
547	C.C.S.SCREW
548	PAPERGUIDE,LEFT
549	SPACER,COVER CARTRIDGE

Table 7-9. Stylus COLOR 580 Parts List

Ref No.	Description
700	PRINT HEAD
701	LEVER,CHANGE
702	COMPRESSION SPRING,0.98
703	HARNES,DETECTOR
704	DETECTOR,HP;C
705	HOLDER,SHAFT
706	LEVER,DETECTOR,HP
707	EDGE GUIDE;B
708	HOPPER
709	FRAME,ASF
710	PAD,HOPPER
711	HOLDER,PAD
712	PAD,LD,SMALL
713	PAD,BRAKE,EDGE GUIDED
714	PAD,LD;D
715	LEVER,DETECTOR,PE
716	ROLLER,LD
717	EXTENSION SPRING,0.143
718	SHAFT,ROLLER,LD
719	CLUTCH
720	SPUR GEAR,35.2
721	COMBINATION GEAR,11.2,32.4
722	COMBINATION GEAR,22.4,32
723	CABLE,HEAD;B
724	COMPRESSION SPRING,4.80

Table 7-9. Stylus COLOR 580 Parts List

Ref No.	Description
725	TORSIONSPRING,25.7
726	TORSIONSPRING,0.22
727	COMPRESSION SPRING 3.75
728	SHAFT,ROLLER,LD,SUPPORT
729	C.P.S-TITE(P4),3X6,F/ZN
730	TRAY,POROUSPAD
731	POROUSPAD,INKEJECT,LARGE
732	POROUSPAD,INKEJECT,SMALL
733	SHEET,PROTECTION;D
734	CLEANER, HEAD ASP
736	HEXAGON NUT
01	INDIVIDUAL CARTON BOX FOR AMERICA
03	PAD PRINTER
04	PLASTIC PROTECTIVE BAG,360X680X0.03T
NON FIG	INK CARTRIDGE,B,OVERSEAS,AS
NON FIG	INK CARTRIDGE,C,OVERSEAS,AS
NON FIG	SOFTWARE CD-ROM,EAI
NON FIG	SETTING UP MANUAL
NON FIG	SETTING UP MANUAL
NON FIG	USER'S GUIDE

7.5 Electrical Circuits

See the following pages for the electric circuit diagrams below:

- C379MAIN-B Circuit board
- C379MAI-C Circuit board
- C367PSB power supply circuit board
- C367PSE power supply circuit board

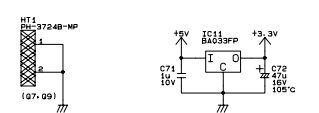
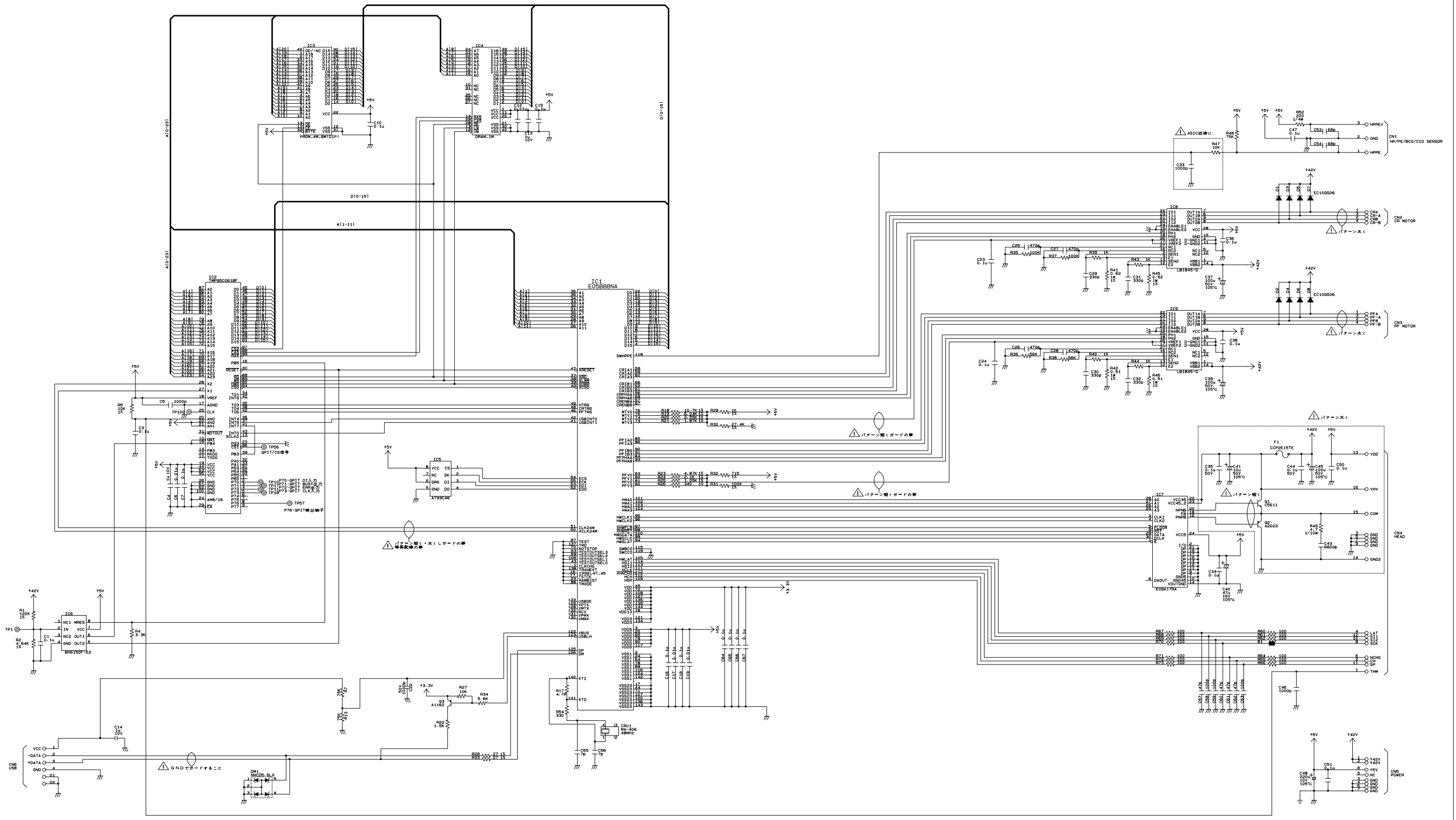

C379MAIN-B Circuit Board

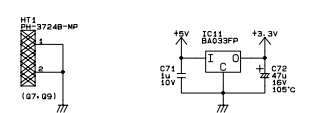
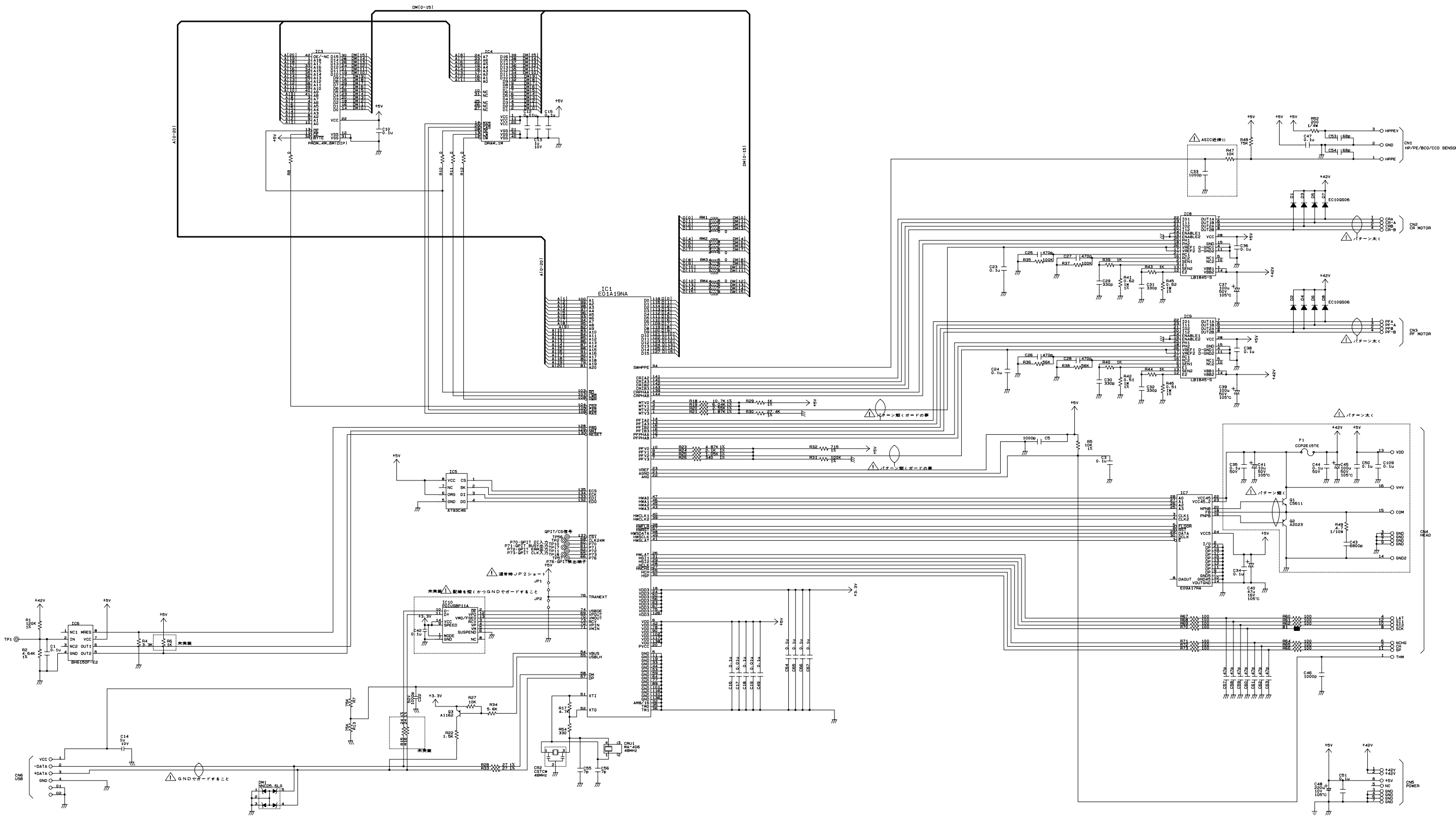

C379MAIN-C Circuit Diagram

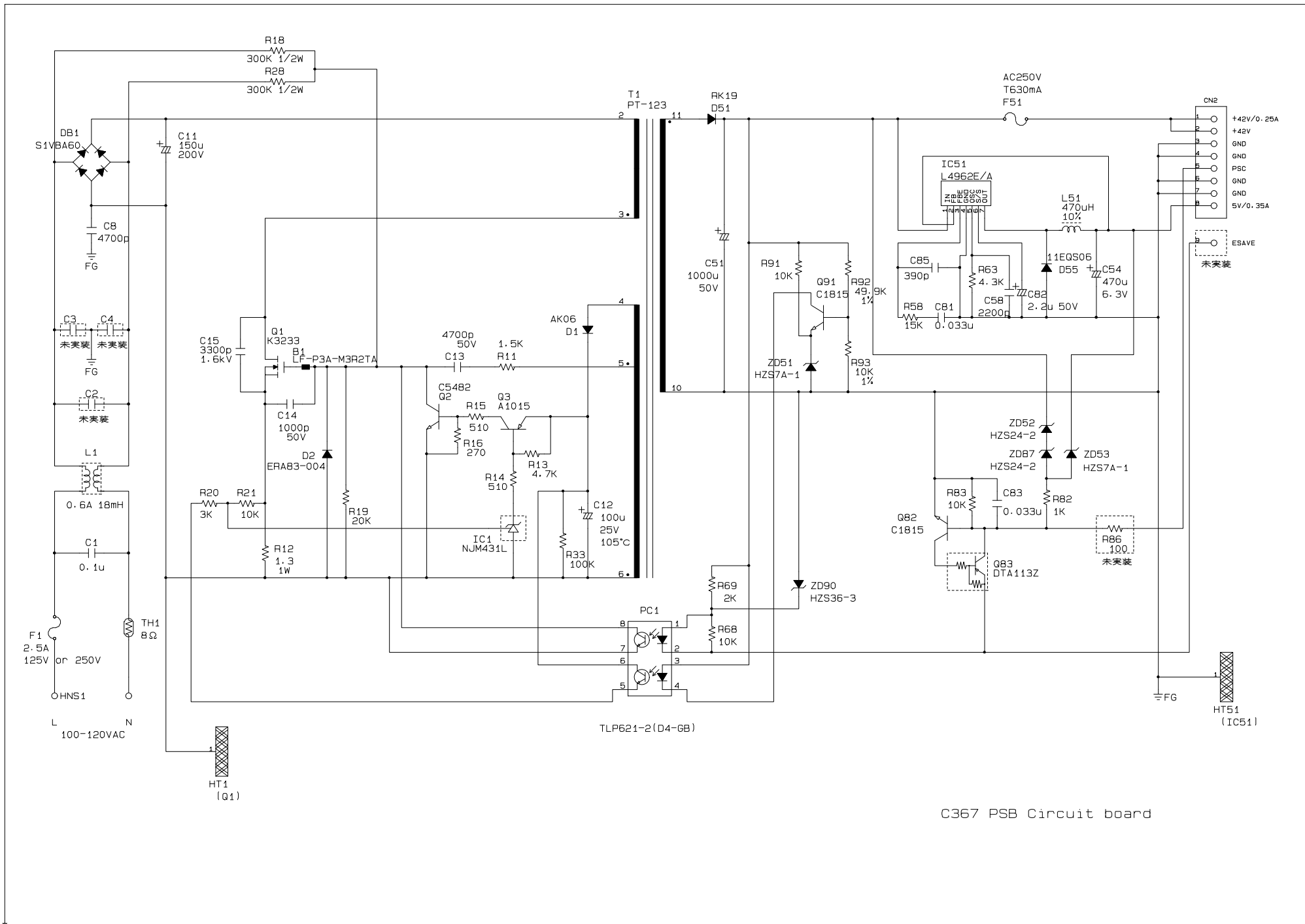

C367 PSB Circuit board

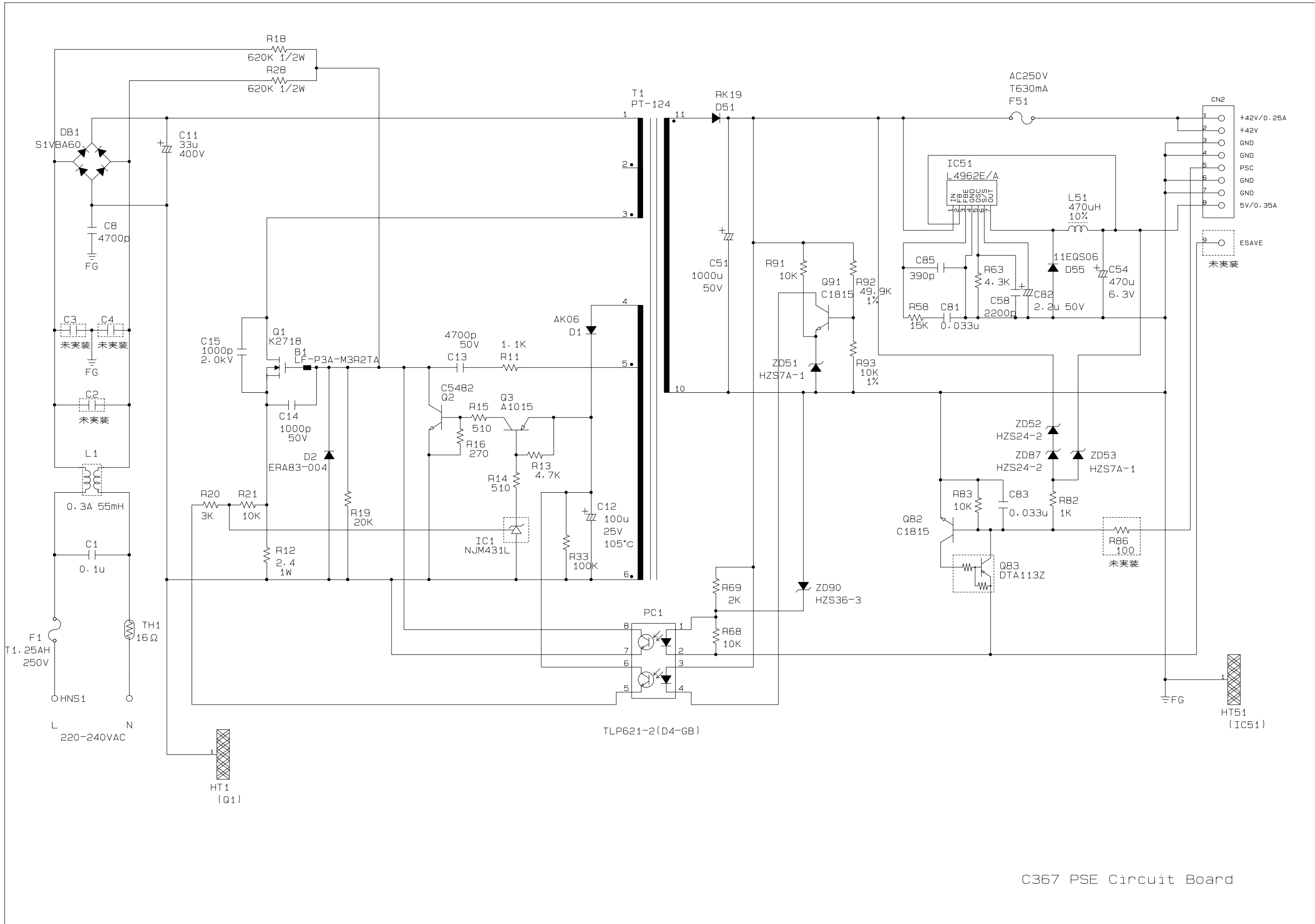

C367 PSE Circuit Board